

VENSTAR®

RESIDENTIAL MODEL T7850

High Resolution, Touch Screen
Digital Thermostat



ColorTouch®



Owner's Manual & Installation Guide



CAUTION

Follow the Installation Instructions before proceeding. Set the thermostat mode to “OFF” prior to changing settings in setup or restoring Factory Defaults.

FCC Compliance Statement

This equipment has been tested and found to comply with the limits for an intentional radiator, pursuant to Part 15, subpart C of the FCC rules. These limits are designed to provide reasonable protection against harmful interference in a residential installation. This equipment generates, uses and can radiate radio frequency energy and, if not installed and used in accordance with the instructions, may cause harmful interference in radio communications. However, there is no guarantee that the interference will not occur in a particular installation. If this equipment does cause harmful interference to radio or television reception, which can be determined by turning the equipment off and on, the user is encouraged to try to correct the interference by one or more of the following measures:

- Reorient or relocate the receiving antenna.
- Increase the separation between the equipment and receiver.
- Connect the equipment into an outlet on a circuit different from that of the receiver.
- Consult the dealer or an experienced radio or TV technician for help.

Notice: Only peripherals complying with FCC limits may be attached to this equipment. Operation with noncompliant peripherals or peripherals not recommended by Venstar, is likely to result in interference to radio and TV reception. Changes or modifications to the product, not expressly approved by Venstar could void the user's authority to operate the equipment.

FCC - INDOOR Mobile Radio Information:

To comply with FCC/IC RF exposure limits for general population / uncontrolled exposure, the antenna(s) used for this transmitter must be installed to provide a separation distance of at least 20 cm from all persons and must not be co-located or operating in conjunction with any other antenna or transmitter.

This Device complies with Industry Canada License-exempt RSS standard(s). Operation is subject to the following two conditions: 1) this device may not cause interference, and 2) this device must accept any interference, including interference that may cause undesired operation of the device.

Under Industry Canada regulations, this radio transmitter may only operate using an antenna of a type and maximum (or lesser) gain approved for the transmitter by Industry Canada. To reduce potential radio interference to other users, the antenna type and its gain should be so chosen that the equivalent isotropically radiated power (e.i.r.p.) is not more than that necessary for successful communication.

Cet appareil est conforme avec Industrie Canada, exempts de licence standard RSS(s). Son fonctionnement est soumis aux deux conditions suivantes: 1) ce dispositif ne doit pas causer d'interférences, et 2) ce dispositif doit accepter toute interférence, y compris les interférences qui peuvent causer un mauvais fonctionnement de l'appareil.

En vertu des règlements d'Industrie Canada, cet émetteur de radio ne peut fonctionner en utilisant une antenne d'un type et maximale (ou moins) Gain approuvé pour l'émetteur par Industrie Canada. Pour réduire les interférences radio potentielles aux autres utilisateurs, le type d'antenne et son gain doivent être choisis afin que la puissance isotrope rayonnée équivalente (PIRE) ne est pas plus de ce qui est nécessaire pour une communication réussie.

We, Venstar, declare under our sole responsibility that the device to which this declaration relates: Complies with Part 15 of the FCC Rules. Operation is subject to the following two conditions: (1) this device may not cause harmful interference, and (2) this device must accept any interference received, including interference that may cause undesired operation.

This color touchscreen has the ability to receive updates to its firmware. Periodically firmware updates are released by the manufacturer to add features and/or performance enhancements. This manual was produced reflecting the most current firmware/feature set at the time of publication, firmware rev. 4.04. Firmware releases after rev. 4.04 may not be adequately depicted in this manual. Please refer to the appropriate website or contact your place of purchase to learn about changes to the thermostat after firmware release 4.04.



Glossary of Terms

- Auto-Changeover:** A mode in which the thermostat will turn on the heating or cooling based on room temperature demand.
- Cool Setpoint:** The warmest temperature that the space should rise to before cooling is turned on (without regard to deadband).
- Deadband:** The number of degrees the thermostat will wait, once a setpoint has been reached, before energizing heating or cooling.
- Differential:** The forced temperature difference between the *heat setpoint* and the *cool setpoint* in *Auto Mode*.
- Heat Setpoint:** The coolest temperature that the space should drop to before heating is turned on (without regard to deadband).
- Icon:** The word or symbol that appears on the thermostat display.
- Mode:** The current operating condition of the thermostat (i.e. Off, Heat, Cool, Auto).
- Non-Programmable Thermostat:** A thermostat that does not have the capability of running *Time Period Programming*.
- Programmable Thermostat:** A thermostat that has the capability of running *Time Period Programming*.
- Temperature Swing:** *Same as Deadband.*
- Time Period Programming:** A program that allows the thermostat to automatically adjust the *heat setpoint* and/or the *cool setpoint* based on the time of the day. *Same as Schedule.*

Table of Contents

GET TO KNOW YOUR THERMOSTAT

Home Screen	1
Menu Screens.....	1
Dropdown Dashboard.....	2
Care and Use of Your Thermostat	3

QUICK START

Selecting Your Desired Temperature and Mode.....	4
Using the Fan Button	4
Setting the Time & Date.....	5
Setting the Time.....	6
Setting the Date	7
Daylight Savings Setup.....	7
Connecting to Wi-Fi.....	8
WiFi Set up - Create a Skyport Account.....	10

MAIN MENU BUTTONS

SCHEDULE.....	11
View My Schedule.....	12
Edit My Schedule	12
SMART FAN.....	14
Smart Fan On/Off	15
Smart Fan Minimum Runtime.....	15
Start/Stop Times	15
Days to allow Smart Fan operation.....	15
SCREENSAVER	16
Screensaver On/Off	17
ScreensaverSetup	17
Screensaver Preview.....	17
ALERTS	18
View Current Alerts.....	19
Reset Alerts	19
Set/Edit Reminders.....	19
Service Information (Who To Call For Service)	19

Table of Contents

DISPLAY	20
Active Brightness	21
Idle Brightness	21
Night Dimmer	21
Maintenance.....	22
PREFERENCES	23
User Interface Themes	24
Custom Wallpaper	24
Heat/Cool Indicator.....	24
Sound Options	24
VACATION/AWAY	25
Clear Vacation Schedule.....	26
Set Vacation Schedule.....	26
Schedule.....	27
Modes & Setpoints	27
SECURITY	28
Auto Screenlock	29
Setpoint Limits	29
INFORMATION	30
My Thermostat	31
View Runtime Graphs	31
Who to Call for Service.....	31
SETTINGS.....	32
Thermostat Name.....	36
Available Modes	36
SD Card (Import and Export).....	36

Table of Contents

GENERAL SETUP	36
Units (F or C).....	36
Language	37
Smart Recovery On/Off.....	37
Simple Thermostat On/Off.....	37
AUTOMATED DEMAND RESPONSE	38
INSTALLATION SETTINGS	52
Heat & Cool Stages.....	52
Heat & Cool Stages.....	52
Compressor Stages	52
Aux Heat Stages	52
Timers & Deadbands	52
Free Cooling	54
Heat Pump Settings.....	55
Heat Pump Lockout - Enabled/Disabled	55
Heat Pump Lockout Outdoor Temp	55
Aux Heat Lockout Enabled/Disabled	55
Aux Heat Lockout Temp	55
Dual Fuel Settings.....	55
Dual Fuel On/Off.....	55
Changeover With Outdoor Temp On/Off.....	55
Adjust Balance Point.....	55
AUX Output Settings.....	56
Fan Off Delay.....	57
Sensor Settings.....	57
Control Sensor	57
Wired Sensor	57
Calibrate Sensors.....	57
Test Outputs	57
Dealer Information	58
Upgrade Firmware	58
Delete Custom Images	58
Calibrate Clock	58





Table of Contents

Reset to Factory Default Settings	58
Restart Thermostat	58
WI-FI	59
Status.....	59
Setup	59
Local API	61
SKYPORT	64
Account.....	64
EMERGENCY HEAT	65
COLORTOUCH ASSISTANT	66
Installing the ColorTouch Assistant Software	66
Uploading Photos	66
INSTALLATION INSTRUCTIONS.....	68
Remove & Replace the Old Thermostat	68
Wire Connections.....	69
Determining Your Existing Wiring and Equipment	70
Making 4 Wires Work When 5 Wires Are Required.....	72
Making 5 Wires Work When 6 Wires Are Required.....	73
The ColorTouch Thermostat Backplate	74
Explanation Of the Thermostat Dip Switches.....	75
Sample Wiring Diagrams	76
TROUBLESHOOTING.....	79
INDEX	80
WARRANTY	84

Get To Know Your Thermostat

Home Screen

Backlit ColorTouch Display

Connectivity Symbol Table	
	Not connected to Wi-Fi
	Connected to local access point w/IP address without Skyport enabled
	Connected to local access point w/IP address, but not yet connected to Skyport
	Connected to Skyport

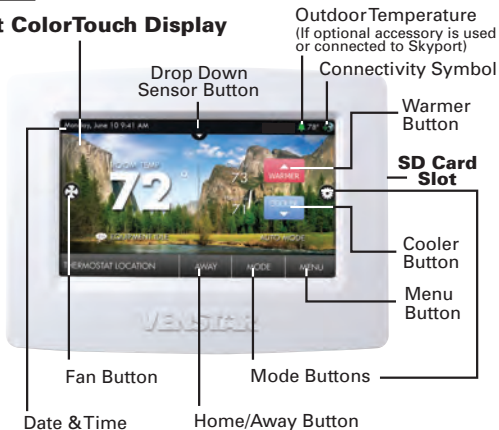

Main Menu Screen

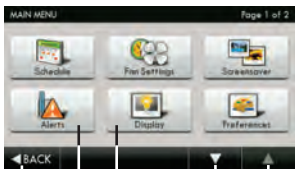

Back Button

Menu Buttons

Scrolling Buttons

Sub Menu Screen

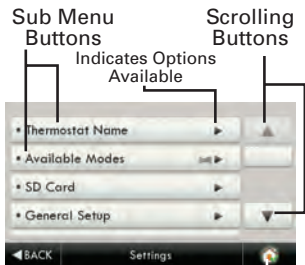

Home Button

Get To Know Your Thermostat





Dropdown Dashboard

The Dropdown Dashboard displays temperature, humidity, and other readings. It will also show the high and low readings of the day.

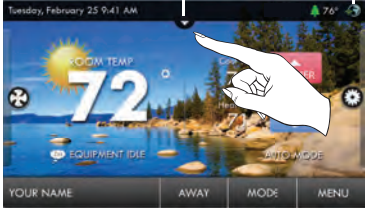
Drop Down Dashboard Button

Wi-Fi Connection Icon



	Not connected to Wi-Fi
	Connected to local access point w/IP address without Skyport enabled
	Connected to local access point w/IP address, but not yet connected to Skyport
	Connected to Skyport

Dropdown Dashboard

(The contents of your Dashboard may vary)

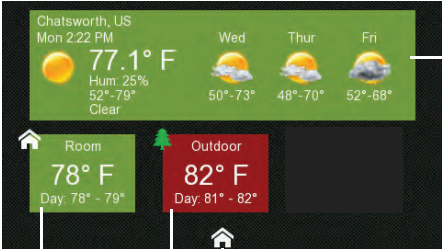

Weather Display

Chatsworth, US
Mon 2:22 PM

77.1° F
Hum: 25%
52°-79°
Clear

Wed 50°-73°
Thur 48°-70°
Fri 52°-68°

Room Temp
78° F
Day: 78° - 79°

Outdoor Temp
82° F
Day: 81° - 82°

Press the HOME button to return to the Home Screen

Get To Know Your Thermostat

Care and Use of Your Thermostat

Pencils, pens and other sharp objects should never be used on your thermostat; these may damage your touchscreen. Only use your finger tip to press the touchscreen buttons.



Use a soft, damp cloth to clean the screen.

DO NOT USE ABRASIVE CLEANERS OR CLEANERS THAT CONTAIN SOLVENTS. DO NOT SPRAY ANYTHING DIRECTLY ONTO THE THERMOSTAT.

Quick Start - Temperature, Modes & Fan

Selecting Your Desired Temperature and Mode

Press  or  to adjust temperature

The Heat or Cool Setpoint is the temperature the room has to reach before heating or cooling will turn on.

(Without regard to deadband)

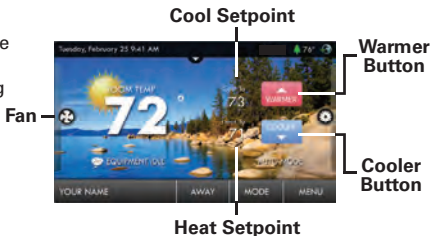

Press  or the **MODE** Icon 

HEAT will allow only heat operation.

COOL will allow only cool operation.

AUTO will allow both Heat and Cool operation.

OFF - heating and cooling systems are turned off.

AUTO-CHANGEOVER MODE - Pressing the WARMER or COOLER buttons in Auto mode will adjust both the heat and cool setpoints simultaneously. To adjust heat and cool setpoints individually, choose HEAT mode to adjust the heat setpoint and COOL mode to adjust the cool setpoint, then return to AUTO mode.

HEAT OR COOL MODE - Pressing the WARMER or COOLER buttons in Heat or Cool mode will adjust only the heat or cool setpoints.



Using the Fan Button

Press the **FAN** Icon 

FAN ON fan runs constantly even in OFF Mode.

FAN AUTO fan only runs with a heating or cooling demand.

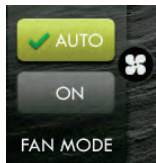

Quick Start - Set Time & Date



NOTE: When the thermostat is connected to a Skyport account, the Time & Date are automatically synchronized to the Skyport Cloud, including automatic Daylight Savings adjustments. Your time zone is selected in the Skyport web application.

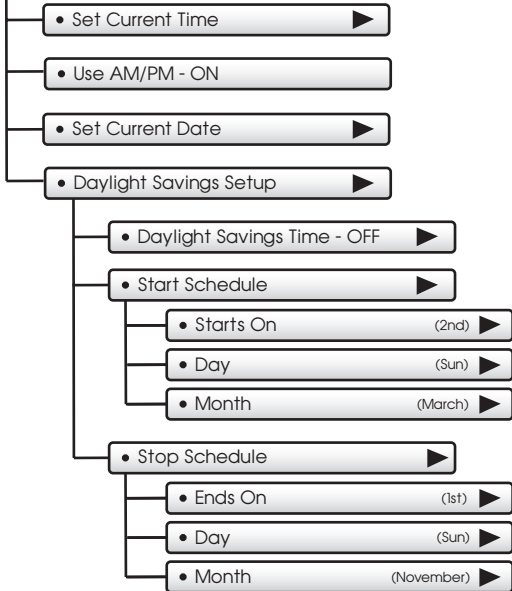

Quick Start - Set Time & Date

Setting the Time

Press **MENU** then **▼** to scroll down.

Press  **Set Time & Date**

Press

• Set Current Time (12:00 AM) 

Press

hr +

min +

and

hr -

min -

to set the current time.

Press



when finished.

Choose

• Use AM/PM - ON 

For 12 hour AM/PM clock

• Use AM/PM - OFF 

For 24 hour clock

Press



when finished.

Quick Start - Set Time & Date

Setting the Date

• Set Current Date 6/1/2013 ▶  Press

Press ◀ or ▶ to set the current month and year.

Press the day on the calendar

Su	Mo	Tu	We	Th	Fr	Sa
27	28	29	30	1	2	3
4	5	6	7	8	9	10
11	12	13	14	15	16	17
18	19	20	21	22	23	24
25	26	27	28	29	30	31
1	2	3	4	5	6	7

◀ ▶

Press ◀ BACK when finished.

• Daylight Savings Setup ▶

Turn Daylight Savings Time on or off.

• Daylight Savings Time - OFF

• Daylight Savings Time - ON 

Adjust when Daylight Savings Time begins.

• Start Schedule

Adjust when Daylight Savings Time ends.

• Starts On (2nd) ▶

• Day (Sun) ▶

• Month (March) ▶

Press ◀ BACK

after making a change to a selection.

• Stop Schedule ▶

• Ends On (1st) ▶

• Day (Sun) ▶

• Month (November) ▶

Press ◀ BACK

or the Home button when finished.

Connect to Wi-Fi (from initial start up)

When power is connected to the thermostat and it has not been configured to connect to a Wi-Fi Access point, the following message appears:

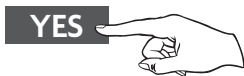
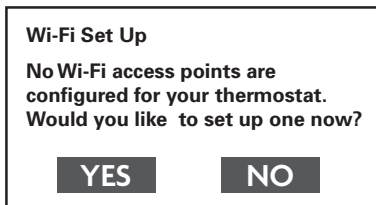

Press YES

Select the access point you wish to connect to from the list.



Enter the password for the Wi-Fi Access Point and press **NEXT**.



Select automatic setup and press **NEXT**.



When finished, a dialog box will appear confirming the successful connection to the local Wi-Fi Access Point.



Select **OK**, then the Wi-Fi status page will appear. Upon closing of the Wi-Fi status page, you will be asked to join the thermostat to a Skyport account.



Select **YES** and follow the onscreen instructions to create a new Skyport account or to add the thermostat to an existing account.

Quick Start - Connect to Wi-Fi (from menus)

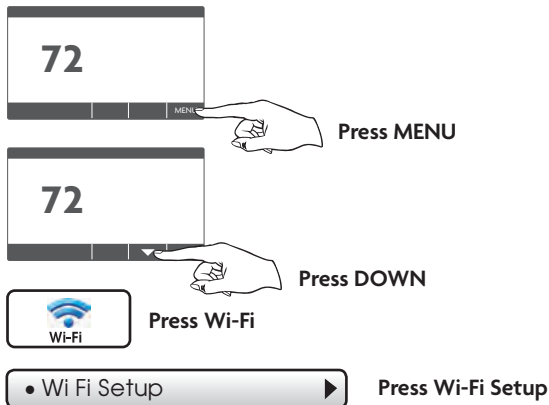

Select the access point from the list that you want to connect to.

↓
Enter the password for the Wi-Fi Access Point and press **NEXT**.

↓
Select automatic setup and press **NEXT**.

↓
When finished, a dialog box will appear confirming the successful connection to the local Wi-Fi Access Point.

↓
Select **OK**, then the Wi-Fi status page will appear. Upon closing of the Wi-Fi status page, you will be asked to join the thermostat to a Skyport account.

↓
Select **YES** and follow the onscreen instructions to create a new Skyport account or to add the thermostat to an existing account.

Quick Start - Connect to Wi-Fi (from menus)

Although there is more than one way to create a Skyport account, the steps below illustrate creation from a browser.

If the thermostat is connected to the local Wi-Fi Access Point, but not yet joined to a Skyport account, you may join the thermostat to an account by doing the following:

Select **MENU** from the thermostat's home screen.



Scroll down



Select Skyport



Select Skyport Account and follow the onscreen instructions.



1. Open your browser to: <https://venstar.skyportcloud.com>
2. Select "Create account now"



3. Follow on screen instructions to create an account and add a thermostat to the Skyport account.

Main Menu Buttons - Schedule

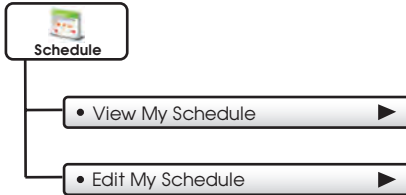

Main Menu Buttons - Schedule



Schedule

This thermostat features up to four programmable time periods per 24 hour day: Morning, Day, Evening, and Night. The start time for each time period is adjustable. The stop time for each time period is the start time for the next period.

• View My Schedule

Press a day of the week to view its settings. This may be repeated for each day.

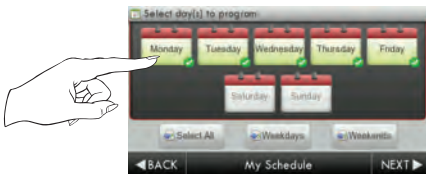

• Edit My Schedule

Press and select days to program

Select individual days

or

Select groups of days

Then press **NEXT**

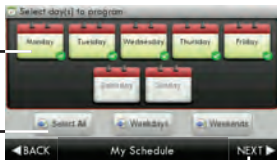

Continued ►

Main Menu Buttons - Schedule

• Edit My Schedule

(Continued)

Press and select a Time Period (Morning, Day, Evening, or Night) to edit.

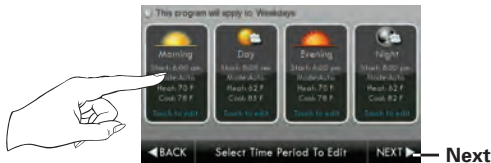

Adjust Mode, Start Time, and Heat and Cool Setpoints to desired settings. The Time Period may also be Enabled or Disabled. Un-check the Enabled box for Time Periods you don't want to use. Press **DONE** when finished.

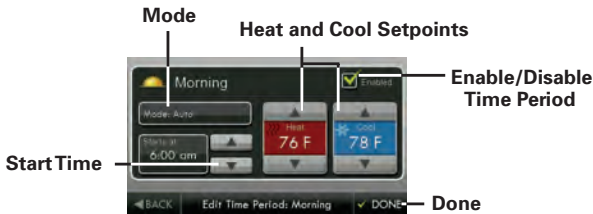

When you are finished editing the four time periods press

NEXT

Review your program.
Press **SAVE** to keep your program.
Press **EDIT** to make further changes.

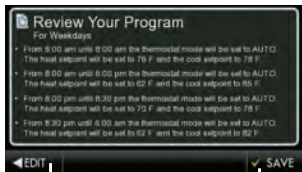

Edit

Save

Main Menu Buttons - Smart Fan

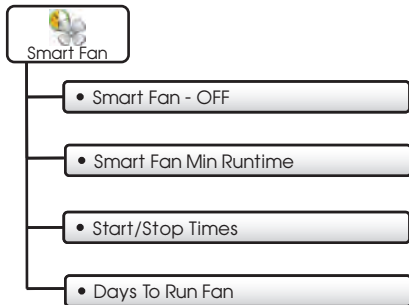

Main Menu Buttons - Smart Fan



Smart Fan

The fan may be programmed to turn on automatically for a specified period during the day.

Press to turn fan schedule on or off

• Smart Fan - OFF

• Smart Fan - ON



• Smart Fan Min Runtime

(10m) ▶

Set the minimum number of minutes the fan will run from the top of each hour. Set runtime to 60 minutes to be on continuously from StartTime to Stop time. (5 - 60 mins.)

• Start/Stop Times

(7:00AM - 9:00PM) ▶

Set when the Smart Fan schedule will start and stop. For example, you may not want Smart Fan to run during sleeping hours.

• Days To Run Fan



Choose which days of the week Smart Fan will run.

Main Menu Buttons - Screensaver

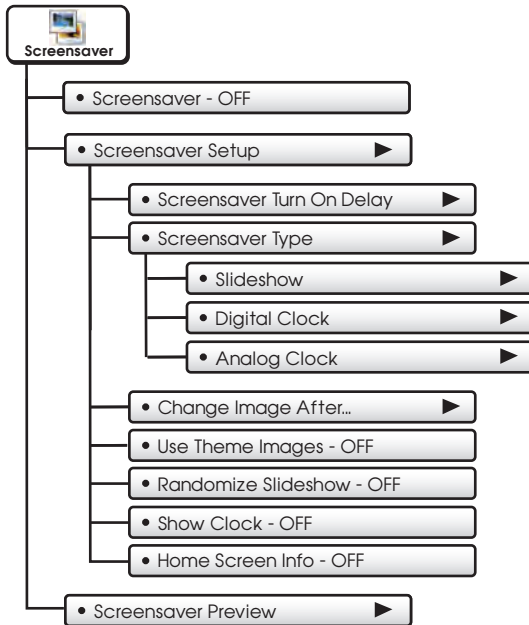

Main Menu Buttons - Screensaver



The Screensaver allows you to create custom slideshows.

• Screensaver - OFF

• Screensaver - ON 

• Screensaver Setup 



• Screensaver Turn On Delay (5m) 

How long after a button press for the Screensaver to appear. 1, 3, 5, or 30 minutes

• Screensaver Type (Slideshow) 

Slideshow, Digital Clock, Analog Clock

• Change Image After... 

15, 30 seconds - 1, 5, or 10 minutes

• Use Theme Images - OFF 

Slideshow uses included Theme Images. Off or On

• Randomize Slideshow - OFF 

Shuffles slideshow photos in random order

• Show Clock - OFF 

Shows the time and date every 5 photos. Off or On

• Home Screen Info - OFF 

Shows the mode, setpoints, and temperature after every 10 photos. Off or On.

• Screensaver Preview 

Press this button to preview your screensaver operation before returning to the Home Screen.

After the preview, press anywhere on the screen to return to the sub menu.

Main Menu Buttons - Alerts

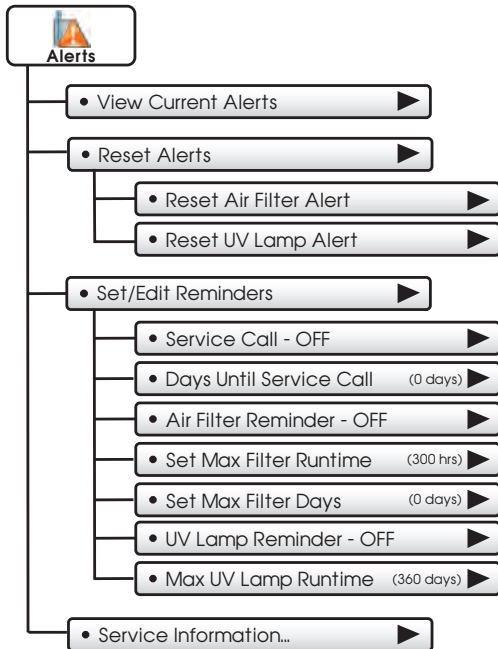

Main Menu Buttons - Alerts



The alerts let you know when your system needs service.

• View Current Alerts

View and reset current service alerts here.



Alerts will appear on the bottom bar of the Home Screen. Press to view and reset current alerts.



• Reset Alerts

Clear and reset current service alerts.

• Set/Edit Reminders

Set service alert runtimes and turn reminders on or off.

• Service Call Reminder - OFF

• Days Until Service Call (0 days)

• Air Filter Reminder - OFF

• Set Max Filter Runtime (500 hrs)

• Set Max Filter Days (300 days)

• UV Lamp Reminder - OFF

• Set Max UV Lamp Runtime (300 days)

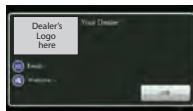

• Service Information...

View your service company's contact information.

Main Menu Buttons - Display

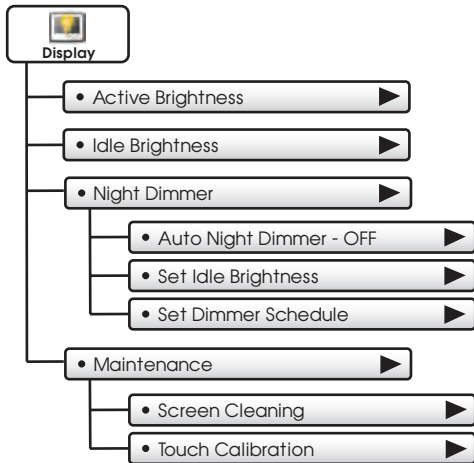

Main Menu Buttons - Display



Display

The display brightness options may be adjusted in this menu.

- Active Brightness (80%) ▶

You may select how bright the backlight is while the thermostat is active. The display is active for 3 minutes after last touch, it then goes Idle.

- Idle Brightness (30%) ▶

You may select how bright the backlight is while the thermostat is idle.

- Night Dimmer ▶

You may dim the brightness of the screen at night.

- Auto Night Dimmer - OFF

The screen can be set to dim automatically at night. Dimming the display can prolong the life of the backlight.

- Set Idle Brightness (20%) ▶

Set the screen brightness for the Night Dimmer. When Night Dimmer is On, the display will go idle 8 seconds after last touch.

- Set Dimmer Schedule ▶

Set the schedule for the Night Dimmer.

Main Menu Buttons - Display

• Maintenance

Maintenance allows you to clean and calibrate the touch screen.

• Screen Cleaning

Screen Cleaning Mode disables the touch feature for 15 seconds so the screen may be cleaned without altering any settings.

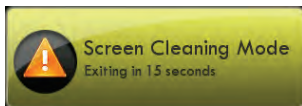

Use a soft cloth without solvents or abrasive cleaners

• Touch Calibration

Under normal circumstances, the touchscreen should not need to be calibrated.

Touch and hold the center of the targets as they appear on the screen for 3 seconds.

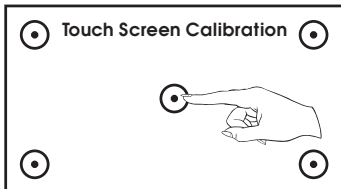

Press **FINISH** when done.

When calibration is complete, the thermostat will automatically restart and return to the Home Screen.

Main Menu Buttons - Preferences

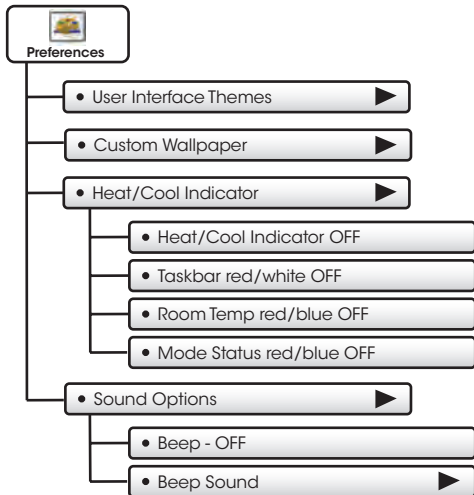

Main Menu Buttons - Preferences



Preferences

You may set the type of background that appears on the thermostat Home Screen.

• User Interface Themes (ocean) ▶

This thermostat has several high quality background themes to choose from.

NOTE: At 7pm, the background will change to an evening scene.

At 7am it will return to a daytime scene.

• Custom Wallpaper ▶

You may choose your own background image by selecting a photo that you have uploaded from an SD memory card.

• Heat/Cool Indicator ▶

You may choose an enhanced indicator of the current status of the HVAC equipment.

- Heat/Cool Indicator - ON/OFF
- Room Temp Red/Blue - ON/OFF
- Taskbar Red/White - ON/OFF
- Mode Status Red/Blue - ON/OFF

• Sound Options ▶

• Beep - ON 

• Beep - OFF

Turn the beep sound on or off.

• Beep Sound (Beep 1) ▶

Choose from different beep sounds.

Main Menu Buttons - Vacation/Away

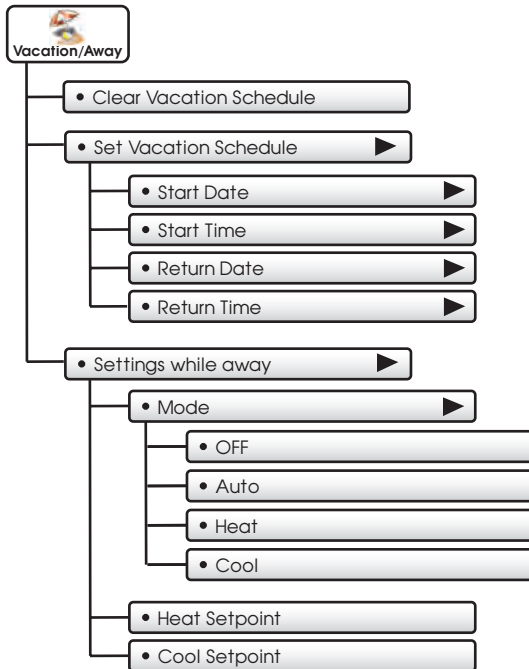

Main Menu Buttons - Vacation/Away



Vacation or pressing the AWAY button, will use temporary, energy saving settings without changing the regular schedule. Pressing the HOME button will return the thermostat to normal comfort settings.

• Clear Vacation Schedule

Removes the stored vacation schedule.

• Set Vacation Schedule ▶

Set your Vacation Schedule.

• Start Date Tue Sep 07 2010 ▶

Select the day Vacation Mode will start.

Then press **◀ BACK**

BACK —



• Start Time (9:00 AM) ▶

Select the time Vacation Mode will start.

Then press **◀ BACK**



Continued ▶

Main Menu Buttons - Vacation/Away

• Schedule ▶

(Continued)

• Return Date Tue Sep 21 2010 ▶

Select the day Vacation Mode will end.

Then press **◀ BACK**

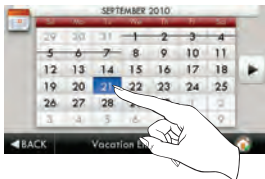

• Return Time (3:00 PM) ▶

Select the time Vacation Mode will end.

Then press **◀ BACK**



• Settings while away ▶

Select the desired Mode and setpoints to be used in Vacation/Away Mode.

• Mode (Auto) ▶

• Heat Setpoint (50°) ▶

• Cool Setpoint (85°) ▶

Main Menu Buttons - Security

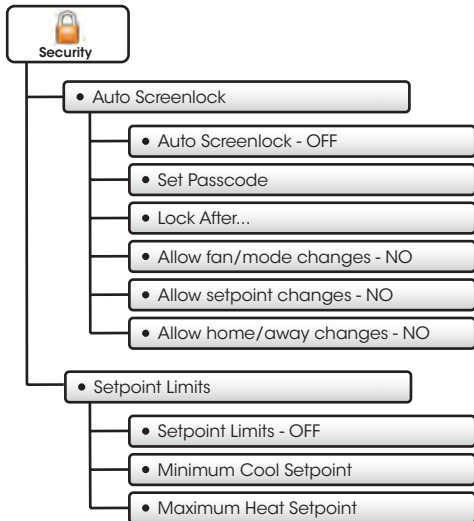

Main Menu Buttons - Security



Security settings may be set to limit or prevent changes to your thermostat.

• Auto Screenlock

- Auto Screenlock - OFF
- Auto Screenlock - ON ✓
- Set Passcode (code not set)

NOTE: Code must be set before Auto Screenlock can be turned on.

Use keypad to enter and confirm passcode.



When the thermostat is locked, the bottom bar of the display will show: 



Press UNLOCK then enter passcode to access thermostat settings.

- Lock After... (5 m)

Set the time the screen will automatically lock after the last button press.

- Allow fan/mode changes - NO

Choose to allow fan/mode changes when Auto Screenlock is on.

- Allow setpoint changes - NO

Choose to allow setpoint changes when Auto Screenlock is on.

- Allow home/away changes - NO

Choose to allow use of the Home and Away button when Auto Screenlock is on.

• Setpoint Limits

Limits how high or low heating and cooling may be adjusted.

Main Menu Buttons - Information

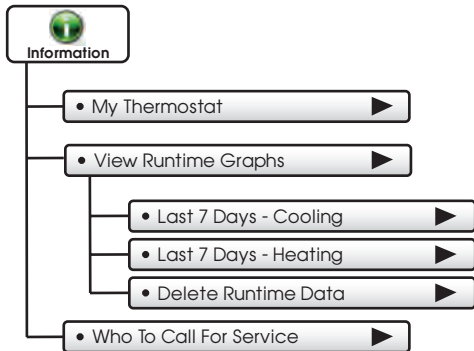

Main Menu Buttons - Information



This button contains valuable service and system runtime information.

• My Thermostat ▶

View your thermostat dip switch settings, equipment status, runtimes, and other settings.

• View Runtime Graphs ▶

Track your system's runtime/energy usage.

• Last 7 Days - Cooling ▶



Press the information icon to learn more about each graph

• Last 7 Days - Heating ▶



*NOTE: The runtime graphs are updated at 12:00 AM each day.

Press anywhere on the screen to return to the submenu.

• Delete Runtime Data ▶

Press to delete your current equipment runtime information.

• Who To Call For Service ▶

Your service company's contact information may be displayed here.

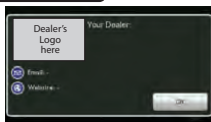

Main Menu Buttons - Settings

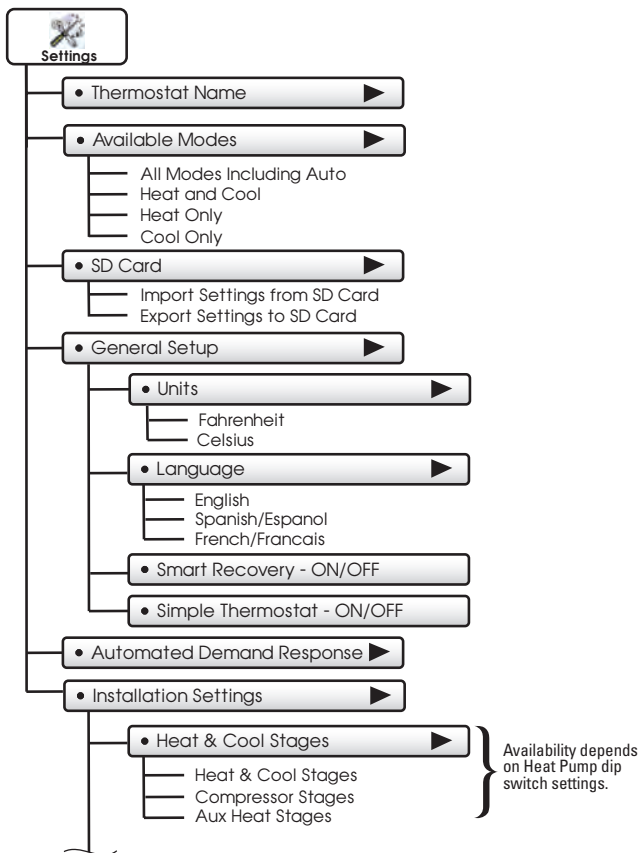

(Continued next page)

Main Menu Buttons - Settings



• Installation Settings ▶ (Continued)

• Timers & Deadbands ▶

- Cycles Per Hour
- Min Heat/Cool Difference
- Compressor Min Off Time
- 1st Stage Deadband
- 2nd Stage Deadband
 - 2nd Stage Deadband
 - 2nd Stage Timer
 - 2nd Stage Turnoff Point
 - Deadband
 - Setpoint
- 3rd Stage Deadband
 - 3rd Stage Deadband
 - 3rd Stage Timer
 - 3rd Stage Turnoff Point
 - Deadband
 - Setpoint
- 4th Stage Deadband
 - 4th Stage Deadband
 - 4th Stage Timer
 - 4th Stage Turnoff Point
 - Deadband
 - Setpoint

• Free Cooling ▶

- Free Cooling - On/Off
- Usable Outdoor Temp
- Mechanical Cooling? - Yes/No

(Continued next page)

Main Menu Buttons - Settings



• Installation Settings ▶

(Continued)

• Heat Pump Settings ▶

— Heat Pump Lockout - Enabled/Disabled

— HP Lockout Outdoor Temp

— Aux Heat Lockout - Enabled/Disabled

— Aux Heat Lockout Temp

— Dual Fuel Settings

— Dual Fuel - On/Off

— Changeover With Outdoor - On/Off

— Adjust Balance Point

• AUX Output Settings

— AUX Output Usage

— AUX Output Polarity

• Fan Off Delay ▶

• Sensor Settings ▶

— Control Sensor

— Thermostat Sensor Only

— Wired Sensor Only

— Average Wired/Thermostat

— Wired Sensor Use

— Use as Outdoor Sensor

— Use as Remote Sensor

— Use as Supply Sensor

— Use as Return Sensor

— Calibrate Sensors

— Thermostat

— Wired Sensor

(Continued next page)

Main Menu Buttons - Settings

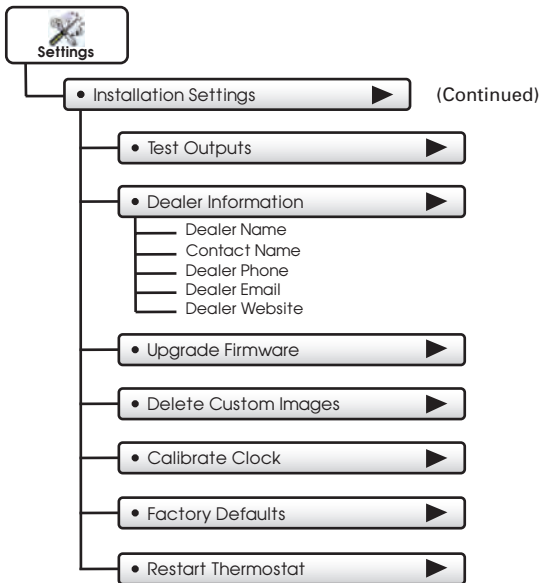

Main Menu Buttons - Settings



Thermostat heating and cooling options are found in this menu

• Thermostat Name ▶

Use keypad to name your thermostat. The name is displayed on the Home Screen.

(Up to 14 characters)

Name appears here



• Available Modes (all) ▶

Choose the desired modes the thermostat will use: Heat, Cool, Heat & Cool, or Auto (All). For example, if you only have a heater, choose Heat, and only Heat & Off modes will be available. This will simplify the operation for the user.

• SD Card ▶

Import and export files to and from the thermostat. See the **ColorTouch Assistant** instructions for further details.

• Import Settings from SD Card ▶

Upload files from ColorTouch Assistant or another thermostat.

• Export Settings to SD Card ▶

Export files from one thermostat and import them into others.

***NOTE:** A 2GB SD card is recommended. To import and export files, the SD card must contain the same version of the firmware as the thermostat. ColorTouch Assistant will keep the firmware current.

• General Setup ▶

• Units (F) ▶

- Fahrenheit (F)
- Celsius (C)

Main Menu Buttons - Settings

• General Setup

(Continued)

• Language

(en) ▶

- English
- Spanish/Español
- French/Français

• Smart Recovery - OFF

• Smart Recovery - ON



Smart Recovery turns on the heat before the Morning start time to bring the room temperature to the Morning setpoint at the start of the Morning time period. Please allow 4-8 days for Smart Recovery time to adjust. When used with a heat pump, electric strip heat will be disabled while Smart Recovery is active.

• Simple Thermostat - OFF

• Simple Thermostat - ON



Turn on Simple Thermostat for the most basic user interface.

When Simple Thermostat is on, alerts will appear in the top bar of the main screen. Press on the top yellow alert bar to view alerts.



Note: When using the SimpleThermostat Home Screen; the program schedule along with the **HOME** and **AWAY** features are unavailable.

Main Menu Buttons - Settings

- Automated Demand Response ►

Overview

ColorTouch thermostats support the handling of specific signals from the utility provider. The utility generated signals carry pricing information and/or setback actions that alter the comfort settings of the thermostat in order to reduce energy usage on demand. This is known as **Automated Demand Response** or ADR for short. You must register to participate in a utility sponsored program, if offered by your local utility, to take advantage of this feature.

SKYPORT CLOUD SERVICES

From the web application the user will select **Thermostat Settings** from the left column. Then the **Demand Response** button is selected.

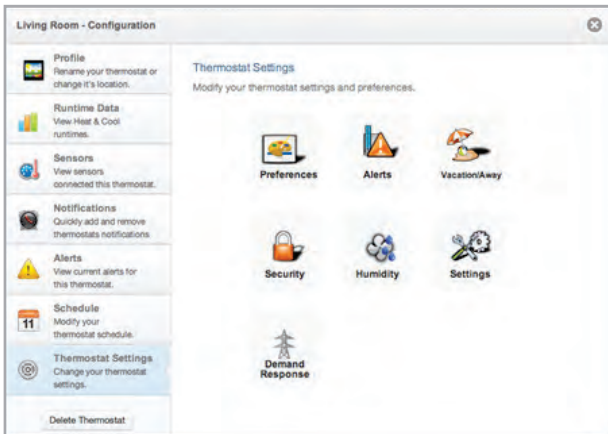

Main Menu Buttons - Settings

The Demand Response configuration page, shown below, is where the thermostat is configured to respond to the energy provider's signals. It also sets operational parameters for the thermostat.

The left column of the ADR configuration page allows or prevents access by the utility. Here communication with the utility and your thermostat may be turned On or Off.

The selected utility will provide a Program ID.

The Account ID would normally be the occupants utility account number.

The screenshot displays the 'Living Room - Configuration' interface. On the left is a sidebar with navigation options: Profile, Runtime Data, Sensors, Notifications, Alerts, Schedule, and Thermostat Settings. The main area is titled 'Automated Demand Response' and has two tabs: 'Configuration' (selected) and 'Overview'. The 'Demand Response' status is currently 'ON'. Below this, there are fields for 'Select Utility' (LADWP), 'Program Id' (test-program), and 'Account Id' (1234). To the right, there are several setting sections: 'Min & Max Settings' (Event Max Cool Setpoint: 85°F, Event Min Heat Setpoint: 65°F), 'Static Settings' (Static Cool Setpoint: 78°F, Static Heat Setpoint: 65°F), 'Offset Settings' (Cool Setpoint Offset: +2, Heat Setpoint Offset: -2), and 'Price Settings' (Price Trigger: 45, Price Dependent Action: Observe Setpoint Offsets). At the bottom, there are 'Cancel' and 'Save' buttons.

Main Menu Buttons - Settings

The right column of the ADR configuration page is where the occupant adjusts the operational parameters for ADR. The utility may send up to 3 types of ADR signals to Skyport. These are:

1) Pricing for the cost of energy, **2) An Offset** to the occupants' comfort setpoints, and **3) a signal** to enforce discrete or Static setpoints.

The Maximum Cooling Setpoint and Minimum Heating Setpoints for ADR events are adjusted here.

The Static Settings are applied when the utility sends a signal to allow the occupant to enforce their own discrete temperature settings during an ADR event.

The Offset Settings allow the utility to modify the Cool or Heat setpoints by the value set here during an ADR event.

A Price Trigger setting allows the occupant to set the maximum cost of energy threshold. When this threshold is exceeded the Price dependent action is enforced. This Price Trigger and Dependent action is enforced independent of an ADR event, as long as the utility sends 'real-time' pricing.

Living Room - Configuration

Profile
Rename your thermostat or change it's location.

Runtime Data
View Heat & Cool runtimes.

Sensors
View sensors connected to this thermostat.

Notifications
Quickly add and remove thermostat notifications

Alerts
View current alerts for this thermostat.

Schedule
Modify your thermostat schedule.

Thermostat Settings
Change your thermostat settings.

Delete Thermostat

Automated Demand Response

Configuration Overview

Demand Response
ON OFF
[What is Demand Response?](#)

Select Utility
LADWP

Program Id:
test-program

Account Id:
1234

Min & Max Settings

Event Max Cool Setpoint: 85°F	Event Min Heat Setpoint: 65°F
----------------------------------	----------------------------------

Static Settings

Static Cool Setpoint: 78°F	Static Heat Setpoint: 65°F
-------------------------------	-------------------------------

Offset Settings

Cool Setpoint Offset: +2	Heat Setpoint Offset: -2
-----------------------------	-----------------------------

Price Settings

Price Trigger:
65

Price Dependent Action:
Observe Setpoint Offsets

Cancel Save

Main Menu Buttons - Settings

Selecting the Overview tab of the ADR page will cause a summary of ADR events to be displayed.

The screenshot displays the 'Living Room - Configuration' window. On the left is a sidebar menu with the following items: Profile, Runtime Data, Sensors, Notifications, Alerts, Schedule, and Thermostat Settings. The 'Thermostat Settings' item is selected. Below the menu is a 'Delete Thermostat' button. The main content area shows the 'Automated Demand Response' (ADR) configuration page, with the 'Overview' tab selected. The ADR page contains a table of events and 'Cancel' and 'Save' buttons.

Event Id	Event Type	Status	Start Time	Stop Time
1233407844	Price	Success	08/10/2014 1:00pm	08/10/2014 2:00pm
1233407844	Price	Success	08/15/2014 4:00pm	08/15/2014 5:00pm

Main Menu Buttons - Settings

- Automated Demand Response ▶

Utility and Program setup must be done at the Skyport Cloud Services account. From the thermostat Home Screen, press the 'Menu' button, then select 'Settings'.

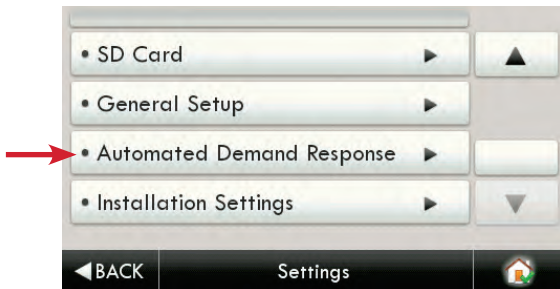

From the above screen the 'Automated Demand Response' button is pressed.

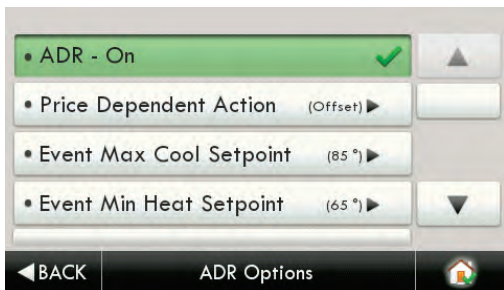

By selecting ADR – On, the user can participate in ADR events triggered by their utility, or price dependent events.

Main Menu Buttons - Settings



Selecting the 'Price Dependent Action' button allows the user to determine what action is taken when the price rises above the set threshold.



In the above example; if the price threshold is exceeded, the thermostat will invoke the 'Offset Setpoints' configured for an ADR event until the event is over.

Please note that the Threshold price may only be set in the Skyport Cloud Services account.

Selecting 'Skip Event' will take no action when the set price threshold is exceeded.

Main Menu Buttons - Settings

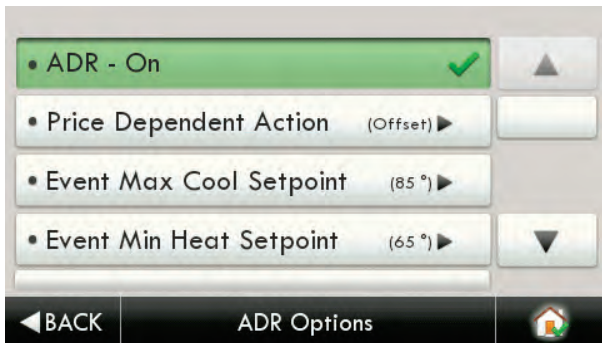

The user may limit the maximum Cooling Setpoint.

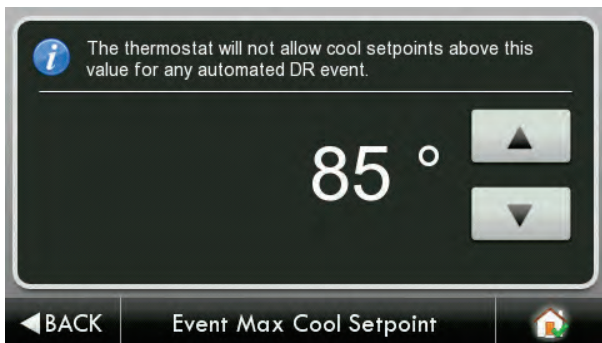

Main Menu Buttons - Settings

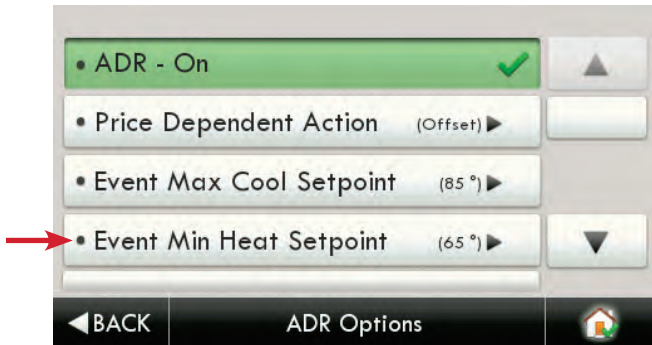

The user may limit the minimum Heating Setpoint.

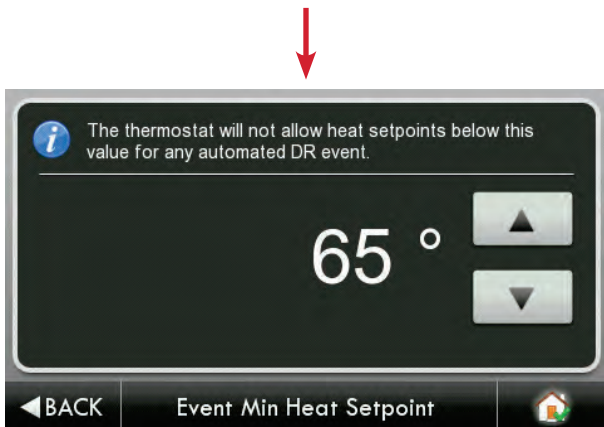

Main Menu Buttons - Settings



The user may adjust the ADR Cooling 'static' Setpoint.

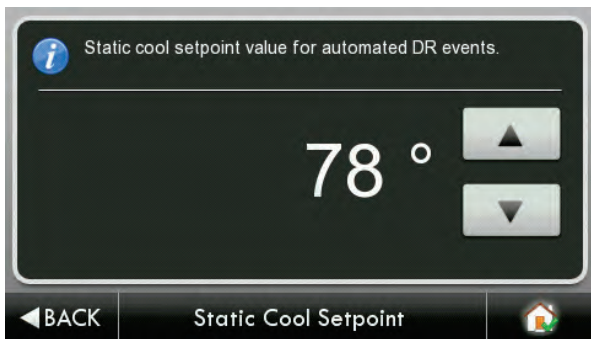

Main Menu Buttons - Settings



The user may adjust the ADR Heating 'static' Setpoint.

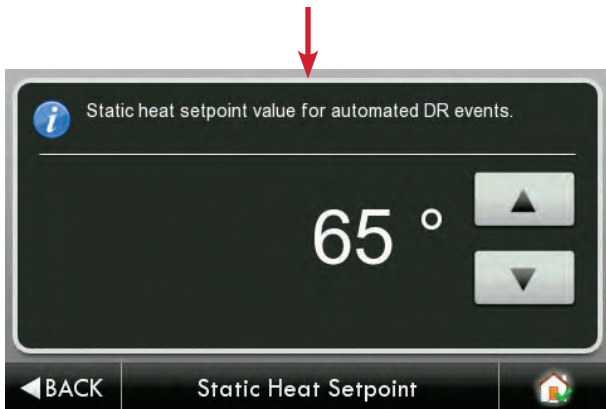

Main Menu Buttons - Settings



The user may adjust the ADR Cool offset. During an ADR event the cooling setpoint will be adjusted by the amount of degrees configured in this step.

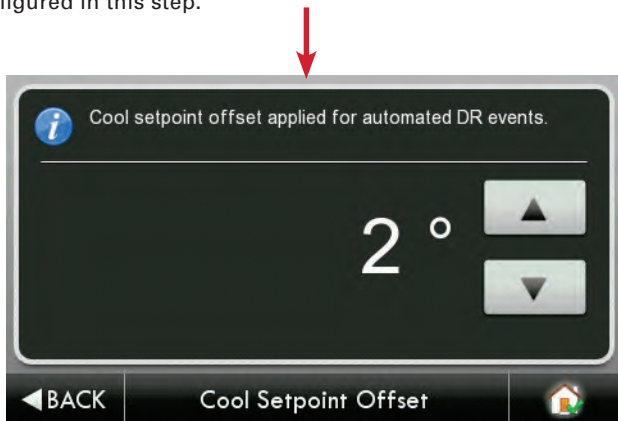

Main Menu Buttons - Settings



The user may adjust the ADR Heat offset. During an ADR event the heating setpoint will be adjusted by the amount of degrees configured in this step.

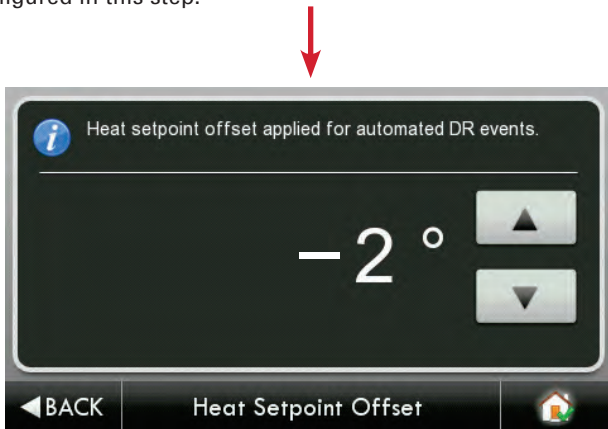

Main Menu Buttons - Settings

When an ADR event is pending, and hasn't started yet, there will be a yellow leaf on the top bar. This will be accompanied by associated text as shown below.



During an ADR event there will be a green leaf on the top bar. This will be accompanied by associated text as shown below.



Main Menu Buttons - Settings

If a Warmer or Cooler button is pressed during an active ADR event, then the user is presented with this opt-out screen.

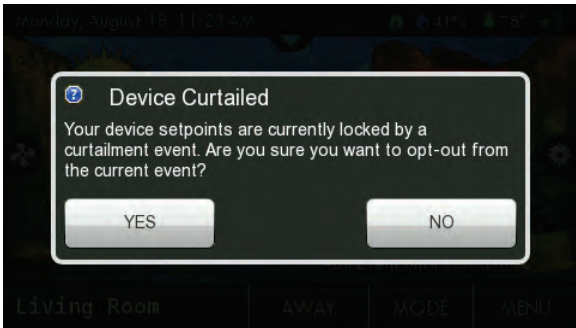

If a pricing triggered ADR event is enabled, there will be a green leaf on the top bar along with the actual cost of energy. This will be accompanied by associated text as shown below



Main Menu Buttons - Settings

• Installation Settings ▶

• Heat & Cool Stages (1h1c) ▶

• Heat & Cool Stages (1h1c) ▶

Up to 2 Stages Cooling and 4 stages Heating.

• Compressor Stages (1h1c) ▶

Up to 2 compressors.

• Aux Heat Stages (1h1c) ▶

0 to 2 stages of Aux Heating.

} Only available when dip switch is set for Heat Pump operation.

• Timers & Deadbands ▶

• Cycles Per Hour (6) ▶

At 6 cycles per hour, the HVAC unit will only be allowed to energize once every 10 minutes. The Cycles Per Hour limit may be overridden and reset by pressing the WARMER or COOLER buttons. (2, 3, 4, 5, 6, No Limit)

• Min Heat/Cool Difference (2°) ▶

The minimum gap between Heat and Cool setpoints. (0 - 6 deg. F)

• Compressor Min OFF Time (5m) ▶

None, 1 minute, or 5 minutes.

Main Menu Buttons - Settings

• Installation Settings ▶

(Continued)

• Timers & Deadbands ▶

(Continued)

The Deadband is the number of degrees or minutes that the thermostat waits before it initiates the stages of heating or cooling.

1st Stage Deadband Specifies the minimum temperature difference between the room temperature and the desired setpoint before the first stage of heating or cooling is allowed to turn on. For example, if the heat setpoint is 68° and the 1st Stage deadband is set to 2 degrees, the room temperature will need to drop to **66 degrees** before the heat turns on.

• 1st Stage Deadband ▶

(2°)

(1 - 6 deg. F)

• 2nd Stage Deadband ▶

• 2nd Stage Deadband ▶

(2°)

Number of degrees past 1st stage before 2nd stage turns on. (0 - 10 deg. F)

• 2nd Stage Timer ▶

(2mins)

Number of minutes past 1st stage before 2nd stage turns on. (0 - 60 mins.)
(The 2nd stage deadband must also be met)

• 2nd Stage Turnoff Point (Deadband) ▶

Deadband or Setpoint.

• 3rd Stage Deadband ▶

• 4th Stage Deadband ▶

The 3rd and 4th stage deadband settings have the same adjustable steps as 2nd stage deadband.

Main Menu Buttons - Settings

• Installation Settings ▶

(Continued)

• Free Cooling ▶

Free Cooling requires additional dampers and duct work to be installed. Additionally, the thermostat is wired in a different manner for this feature to function properly. Before enabling this feature, please make sure these steps are completed.

• Free Cooling - DISABLED

• Free Cooling - ENABLED ✓

Turns on Free Cooling.

• Usable Outdoor Temp (65) ▶

Free Cooling shuts off above this outdoor temperature. (40 - 80 degrees F)

• Mechanical Cooling? - NO

• Mechanical Cooling? - YES ✓

If you don't have a compressor, set Mechanical Cooling to "NO"; Y1 will then be used to control the Free Cooling Damper(s) and Y2 will be disabled. If set to "YES", mechanical (compressor) cooling will be controlled by the Y2 terminal. (See page 67 for wiring diagram)

Mechanical air conditioning is turned on with a 2nd stage demand for cooling and the Free Cooling, outdoor air damper is closed.

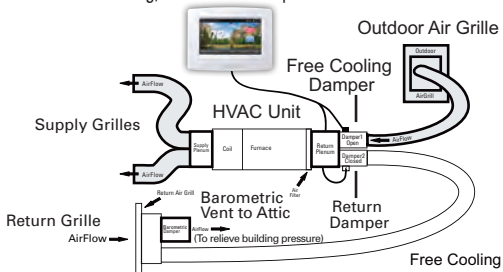

Main Menu Buttons - Settings

• Installation Settings ▶

(Continued)

• Heat Pump Settings ▶

(Only available when dip switch is set for Heat Pump operation.)

• Heat Pump Lockout - DISABLED ▶

• Heat Pump Lockout - ENABLED ✓

Turns on Heat Pump Lockout.

• HP Lockout Outdoor Temp (65°) ▶

Heat Pump will not run below this temp. (20 - 75 deg. F)

• Aux Heat Lockout - DISABLED ▶

• Aux Heat Lockout - ENABLED ✓

Turns on Aux Heat Lockout.

• Aux Heat Lockout Temp (65°) ▶

Aux Heat will not run above this temp. (0 - 75 deg. F) **GAS/EL** or **HP** dip switch must be set for **HP** and **GAS** or **ELEC** dip switch must be set for **ELEC**.

• Dual Fuel Settings ▶

This feature is for heat pump applications only.

This will only appear if the GAS/EL or HP dip switch is set for HP and the GAS or ELEC dip switch is set for Gas.

When Dual Fuel is ON, an outdoor temperature or, if Change With Outdoor is set to OFF a demand for third stage heat will be used to stop running the heat pump and switch to a fossil fuel source of heat. **NOTE:** Once the change to fossil fuel is made, the heat demand must finish with fossil fuel. Additional heat demands within 10 minutes will also use fossil fuel, regardless of outdoor temperature or stage demand.

• **Dual Fuel - ON/OFF**

• **Changeover With Outdoor - ON/OFF**

ON: Uses an outdoor sensor for changeover.

OFF: Uses a third stage heat demand for changeover.

• **Adjust Balance Point**

Choose the temperature for changeover to fossil fuel. (0 - 60 deg. F)

Main Menu Buttons - Settings

• Installation Settings



• AUX Output Settings



Main Menu Buttons - Settings

• Installation Settings ▶ (Continued)

• Fan Off Delay (0s) ▶

Runs the fan for a short time after Cooling or electric strip heat turns off to increase system efficiency. (0 - 120 Secs.)

• Sensor Settings ▶

• Control Sensor (thermostat) ▶

When a remote sensor is connected to the thermostat, the user may choose which sensor source is used to measure room temperature.

- Thermostat sensor only
- Remote Sensor only
- Average remote/thermostat

• Wired Sensor Use (remote) ▶

The wired sensor may be used as follows:

- Outdoor sensor
- Remote Sensor
- Supply Sensor
- Return Sensor

• Calibrate Sensors (0°) ▶

The thermostat and wired sensor may be calibrated -7 to +7 degrees F. The integral humidity sensor may be calibrated -20% to +20% RH

• Test Outputs ▶

The installer or service technician can use this feature to test the functions without any time delays of the thermostat.



With a 1st stage cooling call, Y1 and G are active

Main Menu Buttons - Settings

• Dealer Information ▶

A Dealer may enter their company contact information for the customer to use when they need service. This will appear when the “Who To Call For Service” button is pressed in the Information Menu.

Use the keyboard to enter your information.

- Dealer Name
- Contact Name
- Dealer Phone
- Dealer Email
- Dealer Website

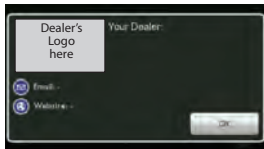

• Upgrade Firmware ▶

Press to upgrade the thermostat firmware. The SD Card must be in the thermostat SD Card reader and contain the valid firmware. If an error message appears, confirm with ColorTouch Assistant that firmware is up to date or simply try reinserting the SD card.

If you are connected to Skyport Wi-Fi and you receive an Alert that new firmware is available, simply press the Upgrade Firmware button to upgrade wirelessly.

Note: Occasionally an update that requires a large amount of data is not possible to do wirelessly. In this case an update using an SD card will be required.

• Delete Custom Images ▶

Press to delete the custom photos you uploaded to the thermostat.

• Calibrate Clock (0 mins) ▶

If needed, the clock may be calibrated up to -10 to +10 minutes per month.

• Factory Defaults ▶

Press to reset the thermostat back to the factory settings.

• Restart Thermostat ▶

If needed, press here to restart the thermostat.

Main Menu Buttons - Wi-Fi

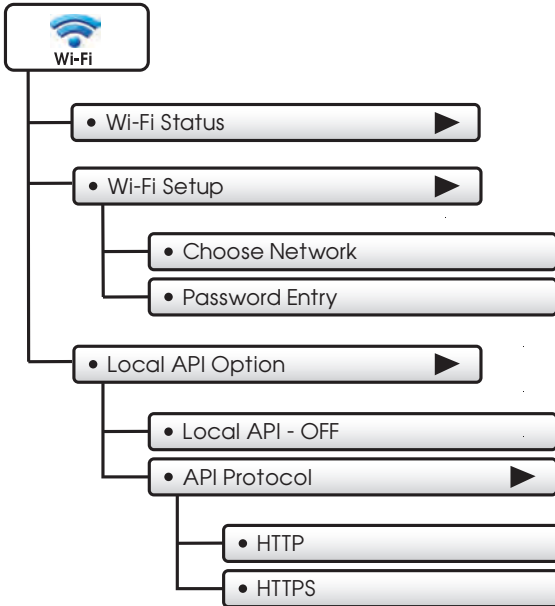

Main Menu Buttons - Wi-Fi



• Wi-Fi Status

It is here that you will find helpful information regarding the connectivity status of your thermostat, including the thermostat's ID.



• Wi-Fi Setup

Choose your network from the list and enter the network password.

 If your network does not appear in the list, hit the refresh button.

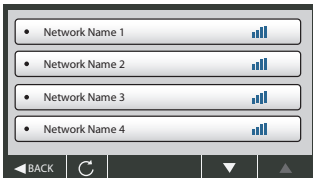

• Local API Option

Turning on the local API allows 3rd party software to interface with your thermostat, such as a home automation system.

Main Menu Buttons - Wi-Fi

This is the default with the local API OFF.

• Local API - OFF

• API Protocol (http) ▶

To turn on the HTTP Local API select **Local API**

• Local API - ON ✓

• API Protocol (http)

Press **BACK** to return to previous screen.

If a Secure API is preferred, then select **API Protocol**

• Local API - OFF

• API Protocol (http) ▶

Upon pressing **API Protocol**, the following screen will appear.

• HTTP ✓

• HTTPS

Then select **HTTPS** and press **BACK**

• HTTP

• HTTPS ✓

Main Menu Buttons - Wi-Fi

Upon pressing **BACK**, the screen will look like this.

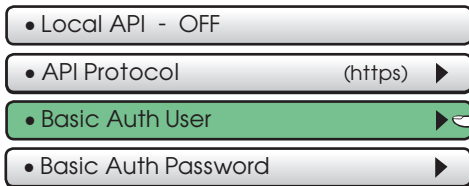

PRESS



Select **Basic Auth User**, and enter the appropriate information on the screen below and press **DONE** to save.

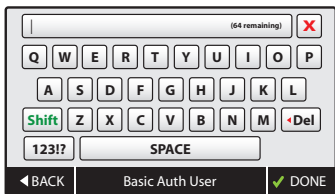

Select **Basic Auth Password** as the next step.

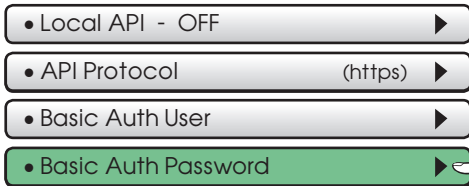

PRESS

Main Menu Buttons - Wi-Fi

• Basic Auth Password ▶

Select **Basic Auth Password** and enter the appropriate information on the screen below and press **DONE** to save.



The last step is to turn the **Local API** as shown below.

• Local API - ON ✓

• API Protocol (https)

• Basic Auth User ▶

• Basic Auth Password ▶

Main Menu Buttons - Skyport

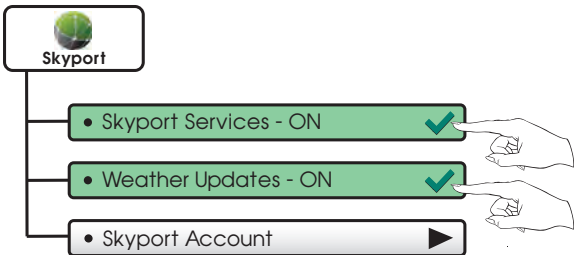

• Skyport Account ▶

Pressing this button will let you know if you are paired with a Skyport account. If not, then you may follow prompt and instructions to create an account and add the thermostat to the account.

Main Menu Buttons - Emergency Heat



The Emergency Heat function is only available if your thermostat is set to control a Heat Pump.

To initiate the Emergency Heat feature, Press the Emergency Heat button. During Emergency Heat operation the thermostat will turn on the fan and auxiliary stages of heat when there is a demand for heat. The 1st stage of heating and all stages of cooling will be unavailable. To exit Emergency Heat, press the Emergency Heat button.

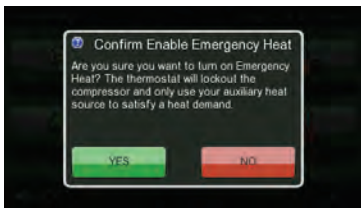

The ColorTouch Assistant

ColorTouch Assistant may be downloaded at no charge at:

www.venstar.com/thermostats/colortouch/assistant



Every time the user runs the ColorTouch Assistant software, it automatically connects to Venstar ColorTouch website in the background and updates the software and firmware (the operating system for ColorTouch) at no cost.

The **ColorTouch Assistant** allows you to use your computer to:

- Upload photos for background and slideshow images
- Program a time period schedule
- Configure installation settings
- Upload dealer and service contact information and company logo
- An alternative method to update thermostat firmware

The ColorTouch Assistant

Uploading Photos and Settings to your thermostat

When you are finished adding and editing photos and settings, click on **Save to SD**. When prompted, remove the SD card from the SD card reader on your computer.



Save to SD

*NOTE: A 2GB SD card is recommended.

At the thermostat:

Insert the SD card into the SD Card Slot.

Press

MENU

then



Next, press



SD Card Slot

Press

• SD Card



Then press

• Import Settings from SD Card



Select the items to import into your thermostat then press

NEXT



Your thermostat will automatically save your new photos and settings in its internal memory. When finished, you may remove the SD card. It is not needed for normal thermostat operation.

Installation Instructions

Remove and Replace the old thermostat

To install the thermostat properly, please follow these step by step instructions. If you are unsure about any of these steps, call a qualified technician for assistance.

- Assemble tools: Flat blade screwdriver, wire cutters and wire strippers.

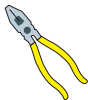

- Make sure your Heater/Air Conditioner is working properly before beginning installation of the thermostat.
- Carefully unpack the thermostat. Save the screws, any brackets, and instructions.
- Turn off the power to the Heating/Air Conditioning system at the main fuse panel. Most residential systems have a separate breaker for disconnecting power to the furnace.
- Remove the cover of the old thermostat. If it does not come off easily, check for screws.
- Loosen the screws holding the thermostat base or subbase to the wall and lift away.
- Disconnect the wires from the old thermostat. Tape the ends of the wires as you disconnect them, and mark them with the letter of the terminal for easy reconnection to the new thermostat. Additionally, we recommend taking a photo with your phone of the connections for future reference.
- Keep the old thermostat for reference purposes, until your new thermostat is functioning properly.

Installation Instructions

Wire Connections

If the terminal designations on your old thermostat do not match those on the new thermostat, **refer to the chart below or the wiring diagrams that follow.**

Wire from the old thermostat terminal marked	Function	Install on the new thermostat connector marked
G or F	Fan	G
Y1, Y	Cooling	Y1
W1, W	Heating	W1/O/B
Rh, R, M, Vr, A	Power	R
C	Common	C
O/B	Rev. Valve	W1/O/B*
W2	2nd Stage Heat	W2
Y2	2nd Stage Cooling	Y2
W3	3rd Stage Heat	W3
OUT -	Outdoor Sensor	SENSOR
OUT +	Outdoor Sensor	SENSOR

* O/B is used if your system is a Heat Pump.

Installation Instructions

Before you go any further, determine what your existing wiring and equipment situation is.

- A. If you have a **Heating only system** without Air Conditioning, the Venstar thermostat will require **3 wires**: R (24Vac), C (24Vac) and W (Heat). Most systems that only have Heating use very simple thermostats that require 2 wires: the R (24Vac) and W (Heat). The Venstar thermostat requires **3 wires** to the thermostat. In this case an Add-a-Wire accessory will not work and it will be necessary to install another wire for the C (24Vac) connection.
- B. If you have a **single stage fossil fuel heater with air conditioning**, the Venstar model will require **5 wires** for independent fan control. They are R (24Vac), C (24Vac), W (Heat), Y (Cooling), and G (Fan). You may connect only 4 wires, as instructed in the “Making 4 Wires Work When 5 Wires Are Required” section on page 74.

If there are only 4 wires present that are connected to the existing thermostat, there are at least 3 options available to connect the Venstar thermostat:

1. Use the 4 wires as instructed in the “Making 4 Wires Work When 5 Wires Are Required” section on page 74, and note that the fan will only operate with a Heating or Cooling demand.
 2. Pull new thermostat wire from the HVAC equipment to the thermostat so that there are at least 5 wires available.
 3. Purchase and install a Venstar Add-A-Wire accessory.
- C. If you have a **multi-stage HVAC system comprised of a fossil fuel heater with air conditioning**, the Venstar thermostat will require the 5 wires mentioned above (R, C, W, Y, G) plus an additional wire for each additional stage of Heating or Cooling. You may reduce the 5 wire requirement to 4 if you give up independent fan control following the instruction in the “Making 4 Wires Work When 5 Wires Are Required” section on page 53, or use the optional Add-A-Wire accessory.

Installation Instructions

- D. If you have a **heat pump without aux heat**, the Venstar model will require 5 wires: R (24Vac), C (24Vac), W1/O/B (Reversing Valve), Y (1st Stage Compressor), and G (Fan).

If you are short 1 wire, there are at least 3 options available to connect the Venstar thermostat:

1. Use the available wires as instructed in the “Making 4 Wires Work When 5 Wires Are Required” section on page 56 and note that the fan will only operate with a Heating or Cooling demand.
2. Pull new thermostat wire from the HVAC equipment to the thermostat so that there are at least 5 wires available.
3. Purchase and install a Venstar Add-A-Wire accessory.

- E. If you have a **heat pump with aux heat**, the Venstar model will require 6 wires: R (24Vac), C (24Vac), W1/O/B (Reversing Valve), Y (1st Stage Compressor), W2 (Aux Heat), and G (Fan).

If you are short 1 wire, there are at least 3 options available to connect the Venstar thermostat:

1. Use the available wires as instructed in the “Making 5 Wires Work When 6 Wires Are Required” section on page 57 and note that the fan will only operate with a Heating or Cooling demand.
2. Pull new thermostat wire from the HVAC equipment to the thermostat so that there are at least 6 wires available.
3. Purchase and install a Venstar Add-A-Wire accessory.

Installation Instructions

Making 4 Wires Work When 5 Wires Are Required

If you would like to install the Venstar thermostat using only 4 wires when 5 are required, follow the directions below. You will need a screwdriver along with a 3" long piece of thermostat wire to use as a jumper:

1. Make sure the power is off.
2. Label and disconnect wires at the thermostat. Please note the color and corresponding wire designator with each color. *For example: The R wire is red and the W wire is white and so on.* You will need this information handy for the next step at the HVAC equipment.
3. At the HVAC equipment end of the thermostat wires (usually at the furnace), locate the terminals that the wires are attached to.
4. Remove the "G wire" from the terminal marked G.
5. Place the "G wire" on terminal C.
6. Place one end of the 3" long jumper on terminal G.
7. Place the other end of the 3" long jumper on terminal Y. Please note that there will be more than 1 wire on terminal Y.
8. When connecting the wires to the Venstar thermostat, note that the wire that was previously connected to the G terminal of the old thermostat will now be required to be connected to the C terminal on the Venstar thermostat. **All other wires** will be connected such that the connections on **each end of the individual wires match terminal designations.** *For example: Connect the yellow wire on the thermostat end to the Y terminal on the thermostat. The yellow wire will be connected to the Y terminal on the HVAC equipment end also.*

Installation Instructions

Making 5 Wires Work When 6 Wires Are Required

If you have a system that requires 6 wires, and you would like to install the Venstar thermostat using only 5 wires, follow the directions below. You will need a screwdriver along with a 3" long piece of thermostat wire to use as a jumper:

1. Make sure the power is off.
2. Label and disconnect wires at the thermostat. Please note the color and corresponding wire designator with each color. *For example: The R wire is red and the W wire is white and so on.* You will need this information handy for the next step at the HVAC equipment.
3. At the HVAC equipment end of the thermostat wires (usually at the furnace), locate the terminals that the wires are attached to.
4. Remove the "G wire" from the terminal marked G.
5. Place the "G wire" on terminal C.
6. Place one end of the 3" long jumper on terminal G.
7. Place the other end of the 3" long jumper on terminal Y. Please note that there will be more than 1 wire on terminal Y.
8. When connecting the wires to the Venstar thermostat, note that the wire that was previously connected to the G terminal of the old thermostat will now be required to be connected to the C terminal on the Venstar thermostat. **All other wires** will be connected such that the connections on **each end of the individual wires match terminal designations.** *For example: Connect the yellow wire on the thermostat end to the Y terminal on the thermostat. The yellow wire will be connected to the Y terminal on the HVAC equipment end also.*

Installation Instructions

The Venstar Backplate

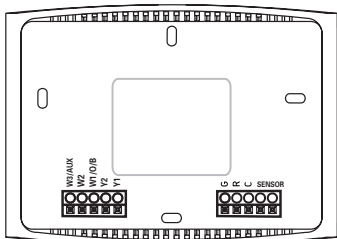

NOTE:

The backplate does not fully cover a full size vertical junction box. The ACC-WPLWH Venstar Wallplate or a single-gang, horizontally mounted junction box would be needed for that type of installation

To remove the thermostat backplate:

Using the Finger Pull Areas, pull the front housing away from the backplate.



Look for these tabs to locate the pull areas

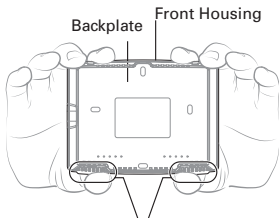

Pull out with thumbs in these areas

W3	3rd stage heat circuit
W2	2nd stage heat circuit
W1/O/B	1st stage heat circuit
Y2	2nd stage compressor relay
Y1	1st stage compressor relay
G	fan relay
R	24 VAC return
C	24 VAC common
SENSOR	remote/outdoor/supply/return sensor connections

IMPORTANT: This thermostat requires both R (24 VAC Return) and C (24 VAC Common) be connected to the backplate terminals.

Installation Instructions

Explanation of Thermostat Dip Switches

Dip switches are located on the back of the thermostat

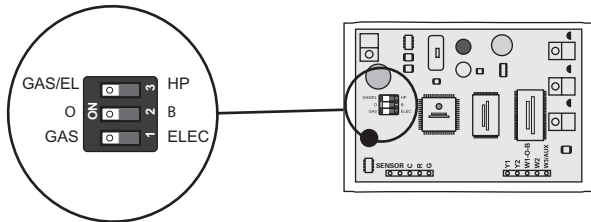

GAS/EL HP GAS/EL HP



OR

This dip switch configures the thermostat to control a conventional gas/electric system or a heat pump. If your system is anything other than a heat pump, leave this switch set for GAS/EL.*

*For some commercial heat pumps, this switch may need to be set for GAS/EL. Consult the commercial heat pump literature.



OR

When the GAS/EL or HP dip switch is configured for HP, this dip switch (O or B) must be set to control the appropriate reversing valve. If O is chosen, the W1/O/B terminal will energize in cooling. If B is chosen, the W1/O/B terminal will energize in heating.



OR

1. When **GAS/EL or HP** is set for **GAS/EL**:
This switch (GAS or ELEC) controls how the thermostat will control the Fan (G) terminal in heating mode. When **GAS** is chosen, the thermostat **will not** energize the Fan (G) terminal in heating. When **ELEC** is chosen the thermostat **will** energize the fan in heating.

2. When **GAS/EL or HP** is set for **HP**:
This switch (GAS or ELEC) defines the Aux Heat type. When **GAS** is chosen, the auxiliary heat will not be allowed to run during heat pump operation. When using a Dual Fuel system, set this switch for **GAS**. When **ELEC** is chosen, up to two stages of auxiliary strip heat will be allowed to run.

Installation Instructions

Sample Wiring Diagrams with Dip Switch Positions

Conventional Heating and Cooling Systems

2 Wire, Heat Only

Residential & Commercial 1 Stage Heating with no Fan.

The thermostat will not work with 2 wires. Either pull new wire or purchase a model ACC0410 two-wire kit

GAS/EL		HP
O		B
GAS		ELEC

3 Wire, Heat Only

Residential & Commercial 1 Stage Heating with no Fan.

R	24VAC Power
C	24VAC Common
W1/O/B	1st Stage Heat

GAS/EL		HP
O		B
GAS		ELEC

4 Wire, Cool Only

Residential & Commercial 1 Stage Cooling.

R	24VAC Power
C	24VAC Common
Y1	1st Stage Cool
G	Fan

GAS/EL		HP
O		B
GAS		ELEC

5 Wire, 1 Stage Cooling, 1 Stage Heat

Residential & Commercial 1 Stage Cooling, with 1 stage Gas Heat.

R	24VAC Power
C	24VAC Common
W1/O/B	1st Stage Heat
Y1	1st Stage Cool
G	Fan

GAS/EL		HP
O		B
GAS		ELEC

5 Wire, 1 Stage Cooling, 1 Stage Heat

Residential & Commercial 1 Stage Cooling, with 1 stage Electric Heat.

R	24VAC Power
C	24VAC Common
W1/O/B	1st Stage Heat
Y1	1st Stage Cool
G	Fan

GAS/EL		HP
O		B
GAS		ELEC

8 Wire, 2 Stage Cooling, 3 Stage Heat

Residential & Commercial 2 Stage Cooling, with 3 stage Gas Heat.

R	24VAC Power
C	24VAC Common
W1/O/B	1st Stage Heat
W2	2nd Stage Heat
W3/AUX	3rd Stage Heat
Y1	1st Stage Cool
Y2	2nd Stage Cool
G	Fan

GAS/EL		HP
O		B
GAS		ELEC

Installation Instructions

Sample Wiring Diagrams with Dip Switch Positions

Heat Pump Systems

5 Wire, 1 Stage Cooling, 1 Stage Heat

Residential & Commercial Heat Pump with
'O' Reversing Valve

R	24VAC Power
C	24VAC Common
W1/O/B	Reversing Valve
Y1	1st Stage Compressor (Cool or Heat)
G	Fan

GAS/EL		HP
O		B
GAS		ELEC

6 Wire, 1 Stage Cooling, 2 Stage Heat

Residential & Commercial Heat Pump with
'O' Reversing Valve

R	24VAC Power
C	24VAC Common
W1/O/B	Reversing Valve
Y1	1st Stage Compressor (Cool or Heat)
W2	Aux Heat
G	Fan

GAS/EL		HP
O		B
GAS		ELEC

7 Wire, 2 Stage Cooling, 3 Stage Heat

Residential & Commercial Heat Pump with
'O' Reversing Valve.

R	24VAC Power
C	24VAC Common
W1/O/B	Reversing Valve
W2	3rd Stage Heat
Y1	1st Stage Compressor (Cool or Heat)
Y2	2nd Stage Compressor (Cool or Heat)
G	Fan

GAS/EL		HP
O		B
GAS		ELEC

(Number of Compressor Stages set to 2)

8 Wire, 2 Stage Cooling, 4 Stage Heat

Residential & Commercial Heat Pump with
'O' Reversing Valve.

R	24VAC Power
C	24VAC Common
W1/O/B	Reversing Valve
W2	3rd Stage Heat
W3	4th Stage Heat
Y1	1st Stage Compressor (Cool or Heat)
Y2	2nd Stage Compressor (Cool or Heat)
G	Fan

GAS/EL		HP
O		B
GAS		ELEC

(Number of Compressor Stages set to 2)

Installation Instructions

Sample Wiring Diagrams with Dip Switch Positions

Heat Pump Systems with Dual Fuel

7 Wire, 2 Stage Cooling, 3 Stage Heat
Residential & Commercial Heat Pump with
'O' Reversing Valve and Fossil Fuel furnace.

R	24VAC Power
C	24VAC Common
W1/O/B	Reversing Valve
W2	3rd Stage Heat (connected to furnace)
Y1	1st Stage Compressor (Cool or Heat)
Y2	2nd Stage Compressor (Cool or Heat)
G	Fan



Number of Compressor Stages
set to 2
(see *Compressor Stages*, pg. 33)

Dual Fuel set to On
(see *Dual Fuel Settings*, pg. 36)

Free Cooling

Use 18-22 gauge thermostat wire.

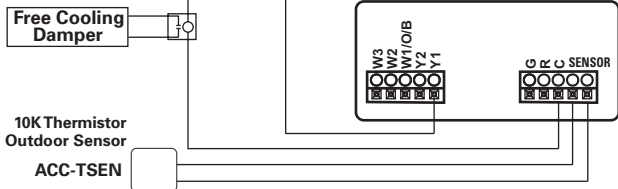

Free Cooling utilizes the Y1 terminal for the operation of 1st stage cooling. If mechanical (compressor) cooling is also present, the mechanical cooling is connected to the Y2 terminal in this instance.

Free Cooling may be used with a Gas/Electric or Heat Pump system.

Temperature Sensor: ACC-TSEN Temperature Sensor 10K ohm sensor at 77F/25C. Negative Temperature Coefficient.

Troubleshooting

- **SYMPTOM:** The thermostat touchscreen buttons are not responsive.
CAUSE: The touchscreen is out of calibration.
REMEDY: Remove the thermostat from the backplate. Push the thermostat back onto the backplate, while keeping your finger pressed firmly against the center of the touchscreen, until the Calibration screen appears. Re-calibrate the touchscreen. *See Touch Calibration section of full user's manual (page 19).*
- **SYMPTOM:** The display is blank.
CAUSE: Lack of proper power.
REMEDY: Make sure the power is on to the HVAC and that you have 24vac between **R & C**.
- **SYMPTOM:** The air conditioning does not attempt to turn on.
CAUSE: The cooling setpoint is set too high.
REMEDY: Lower the cooling setpoint or lower the cooling set-point limit. *See Setpoint Limits (page 28).*
- **SYMPTOM:** The heating does not attempt to turn on.
CAUSE: The heating setpoint is set too low.
REMEDY: Raise the heating setpoint or raise the heating set-point limit. *See Setpoint Limits (page 28).*
- **SYMPTOM:** When controlling a residential heat pump, and asking for cooling, the heat comes on.
CAUSE: The thermostat reversing valve dip switch is set for **"B"**.
REMEDY: Set the reversing valve jumper for **"O"**.
- **SYMPTOM:** When calling for cooling, both the heat and cool come on.
CAUSE: The thermostat equipment dip switch is configured for **"HP"** and the HVAC unit is a Gas/Electric.
REMEDY: Set the equipment dip switch for **"Gas"**.
- **SYMPTOM:** Air handler control board fuse blows when thermostat is attached to backplate with power on, but does not blow until the thermostat is placed onto the backplate.
CAUSE: The Outdoor sensor and/or sensor wiring is shorted.
REMEDY: Check/replace Outdoor sensor and/or sensor wiring.

Index

A

Accessories, 34, 57, 69, 74, 76, 78

Active Brightness, 21

Alerts, 19

- view current, 19
- reset, 19
- set/edit reminders, 19
- See also Runtime*

API, 60, 63

Auto

- adjust temperature, 4
- changeover, 4
- fan, 4
- mode, 4

Automated Demand Response, 38

Auto Screenlock, 29

Aux Heat Lockout, 55

Available Modes, 36

B

B Reversing Valve, 69

Backlight, 21

Backplate, 74

Beep, 24

Buttons,

- Back, 1
- Cooler, 1, 4
- Fan, 1, 4

- Home, 1
- Mode, 1, 4
- Menu, 1, 6
- Warmer, 1, 4

C

C, 69

Calibration, 22, 79

Celsius, 36

Choose Network, 60

Cleaning, 22

Clock

- Display 1
- Setting, 6

ColorTouch Assistant, 66

Compressor Lockout, 52

Cool

- 1st stage deadband, *see Deadband*
- 2nd stage deadband, *see Deadband*
- Minutes of runtime, 31, 52

Custom Wallpaper, 17, 24

Cycles Per Hour, 52

D

Daylight Savings, 7

Deadband

- 1st stage, 53
- 2nd stage, 53

3rd stage, 53

4th stage, 53

Dealer Information, 31, 58

Delay

- Fan-off, *see Fan*
- Time between stages, *see Time Delay*

Differential

- Heat and cool, 52

Dimmer, 21

Dip Switches, 75

- ELEC, 75
- electric heat, 75
- GAS/EL, 75
- GAS, 75
- HP, 75
- heat pump, 75
- O, 75
- B, 75

Disabled Buttons

- see Security*

Display, 21, 22

Dual Fuel

- changeover balance point, 78
- control two heat sources, 78
- operation, 78
- outdoor sensor, 76, 78

E

Electric Heating

- Aux heat, 55
- Dip switch setting, 75
- Lockout, 55

Index

Emergency Heat, 67

Energy Watch

Cool, 29

Heat, 29

Aux heat, 29



Factory Defaults

resetting, 58

Fahrenheit, 36

Fan

button function,
see Buttons

off time delay, 57

on during heat,

see Electric Heat

runtime, 31

2nd stage heat, *see*

Emergency Heat

Free Cooling, 54, 78



Gas/Electric Furnace

dip switch, 75

General Setup, 36



Heat

1st stage

deadband, *see*

Deadband

emergency heat, 65

minutes of

runtime, 31

2nd stage deadband,

see Deadband

electric strip heat,

see Aux Heat

minutes of

runtime, 31

3rd stage deadband,

see Deadband

4th stage deadband,

see Deadband

timer, 53

turnoff point, 53

electric/heat pump, 55

mode, 4

program, *see Schedule*

runtime, *see Runtime*

setpoint, 4

Heat/Cool Indicator, 24

Heat Pump

aux heat, 52, 55

aux heat lockout, 55

emergency heat, 65

heat pump lockout, 55

dip switch setting,

75, 77

multi-stage, 52, 55



Idle Brightness, 21

Information, 31

Installation Settings, 52

Installation, 68



Keypad, 29, 36



Language, 37

Lock

see Security

Logo, 19

Index

M

- Main Menu, 1**
- Maintenance, 22**
- Manual**
 - changeover, 37
 - cool, 4
 - heat, 4
- Mode, 1, 4**
- Morning Warm-up,**
see Smart Recovery
- MultiStage Operation, 70**

N

- Network Password,**
60, 62
- Night Dimmer, 21**
- Non-Programmable
Thermostat, iii**

O

- O Reversing Valve, 75**
- Off Mode, 4**

Outdoor

- calibrate, 57
- high and low temp, 1
- sensor, 76, 78
- viewing temp,

P

- Passcode, 29, 60, 62**
- Photos, 58, 66**
- Preferences, 24**
- Program**
 - daily schedule, 12

R

- Reset**
 - alert messages, 19
 - thermostat settings,
see Factory Defaults
 - runtime,
 - fan/filter, 19
 - UV light, 19
- Reversing Valve, 75, 77**
- Runtime**
 - resetting, *see Reset*
 - service filter, 19
 - UV light, 19
 - viewing, 19, 31

S

- Schedule**
 - turn on/off, 12-13
 - view, 12-13
 - edit, 12-13
- Screen Cleaning, 22**
- Screensaver**
 - turn on/off, 17
 - setup, 17
 - preview, 17
- SD Card, 36**
- 2nd stage turn off**
 - temperature, 53
- Secure API, 61**
- Security, 29**
- Service**
 - alerts, 19
 - information, 30
- Set Clock, *see Clock***
- Setpoint**
 - balance point, 55
 - cool, 4
 - heat, 4
 - limits, 27
 - vacation, 27
- Settings, 31-38**
- Simple Thermostat, 37**
- Skyport Service, 64**
- Smart Fan, 15**
- Smart Recovery, 37**
- Sound Options, 24**
- Stages, 52**

Index

T

Terminals,

see Backplate

Test Outputs, 57

Thermostat Sensor

calibrate, 57

Three Stage Heat, 52

Time, *see Clock*

Timers, 52

Time Delay,

compressor lockout, 52

cycles per hour, 52

1st stage to 2nd stage, 53

2nd stage to 3rd stage, 53

3rd stage to 4th stage, 53

Time schedule,

see Schedule

Touch Calibration, 79

U

Upgrade Firmware, 58

User Interface Themes, 24

UV Light,

resetting, 19

runtime, *see Runtime*

setting, *see Runtime*

V

Vacation

modes, 26

schedule, 26

setpoints, 26

W

W1, 72, 73, 76

W2, 72, 73, 76

W3, 72, 73, 76

Wallpaper, 17, 24

Warranty, 84

Wiring, 71

dual fuel, 78

free cooling, 54, 78

gas/electric, 75

heat pump, 77

Y

Y1, 50

Y2, 50

Warranty

One-Year Warranty - This Product is warranted to be free from defects in material and workmanship. If it appears within one year from the date of original installation, whether or not actual use begins on that date, that the product does not meet this warranty, a new or remanufactured part, at the manufacturer's sole option to replace any defective part, will be provided without charge for the part itself provided the defective part is returned to the distributor through a qualified servicing dealer.

THIS WARRANTY DOES NOT INCLUDE LABOR OR OTHER COSTS incurred for diagnosing, repairing, removing, installing, shipping, servicing or handling of either defective parts or replacement parts. Such costs may be covered by a separate warranty provided by the installer.

THIS WARRANTY APPLIES ONLY TO PRODUCTS IN THEIR ORIGINAL INSTALLATION LOCATION AND BECOMES VOID UPON REINSTALLATION.

LIMITATIONS OF WARRANTIES – ALL IMPLIED WARRANTIES (INCLUDING IMPLIED WARRANTIES OF FITNESS FOR A PARTICULAR PURPOSE AND MERCHANTABILITY) ARE HEREBY LIMITED IN DURATION TO THE PERIOD FOR WHICH THE LIMITED WARRANTY IS GIVEN. SOME STATES DO NOT ALLOW LIMITATIONS ON HOW LONG AN IMPLIED WARRANTY LASTS, SO THE ABOVE MAY NOT APPLY TO YOU. THE EXPRESSED WARRANTIES MADE IN THIS WARRANTY ARE EXCLUSIVE AND MAY NOT BE ALTERED, ENLARGED, OR CHANGED BY ANY DISTRIBUTOR, DEALER, OR OTHER PERSON WHATSOEVER.

ALL WORK UNDER THE TERMS OF THIS WARRANTY SHALL BE PERFORMED DURING NORMAL WORKING HOURS. ALL REPLACEMENT PARTS, WHETHER NEW OR REMANUFACTURED, ASSUME AS THEIR WARRANTY PERIOD ONLY THE REMAINING TIME PERIOD OF THIS WARRANTY.

THE MANUFACTURER WILL NOT BE RESPONSIBLE FOR:

1. Normal maintenance as outlined in the installation and servicing instructions or owner's manual, including filter cleaning and/or replacement and lubrication.
2. Damage or repairs required as a consequence of faulty installation, misapplication, abuse, improper servicing, unauthorized alteration or improper operation.
3. Failure to start due to voltage conditions, blown fuses, open circuit breakers or other damages due to the inadequacy or interruption of electrical service.
4. Damage as a result of floods, winds, fires, lightning, accidents, corrosive environments or other conditions beyond the control of the Manufacturer.
5. Parts not supplied or designated by the Manufacturer, or damages resulting from their use.
6. Manufacturer products installed outside the continental U.S.A., Alaska, Hawaii, and Canada.
7. Electricity or fuel costs or increases in electricity or fuel costs for any reason whatsoever including additional or unusual use of supplemental electric heat.
8. ANY SPECIAL INDIRECT OR CONSEQUENTIAL PROPERTY OR COMMERCIAL DAMAGE OF ANY NATURE WHATSOEVER. Some states do not allow the exclusion of incidental or consequential damages, so the above may not apply to you.

This warranty gives you specific legal rights and you may also have other rights which may vary from state to state.

Patents Issued & Pending



Printed on recycled paper.
P/N 88-1087 Rev. 1 04/15

VENSTAR®