

VENSTAR®

DIGITAL THERMOSTAT

RESIDENTIAL MODEL T2000

7 Day Programmable • Up to 2-heat & 2-cool

EXPLORER Mini

with
Wi-Fi
and local
API



**Owner's Manual
& Installation
Instructions**



CAUTION

Follow the Installation Instructions before proceeding. Set the thermostat mode to “OFF” prior to changing settings in setup or restoring Factory Defaults.

FCC Compliance Statement

This equipment has been tested and found to comply with the limits for an intentional radiator, pursuant to Part 15, subpart C of the FCC rules. These limits are designed to provide reasonable protection against harmful interference in a residential installation. This equipment generates, uses and can radiate radio frequency energy and, if not installed and used in accordance with the instructions, may cause harmful interference in radio communications. However, there is no guarantee that the interference will not occur in a particular installation. If this equipment does cause harmful interference to radio or television reception, which can be determined by turning the equipment off and on, the user is encouraged to try to correct the interference by one or more of the following measures:

- Reorient or relocate the receiving antenna.
- Increase the separation between the equipment and receiver.
- Connect the equipment into an outlet on a circuit different from that of the receiver.
- Consult the dealer or an experienced radio or TV technician for help.

Notice: Only peripherals complying with FCC limits may be attached to this equipment. Operation with noncompliant peripherals or peripherals not recommended by Venstar, is likely to result in interference to radio and TV reception. Changes or modifications to the product, not expressly approved by Venstar could void the user's authority to operate the equipment.

FCC - INDOOR Mobile Radio Information:

To comply with FCC/IC RF exposure limits for general population / uncontrolled exposure, the antenna(s) used for this transmitter must be installed to provide a separation distance of at least 20 cm from all persons and must not be co-located or operating in conjunction with any other antenna or transmitter.

This Device complies with Industry Canada License-exempt RSS standard(s). Operation is subject to the following two conditions: 1) this device may not cause interference, and 2) this device must accept any interference, including interference that may cause undesired operation of the device.

Under Industry Canada regulations, this radio transmitter may only operate using an antenna of a type and maximum (or lesser) gain approved for the transmitter by Industry Canada. To reduce potential radio interference to other users, the antenna type and its gain should be so chosen that the equivalent isotropically radiated power (e.i.r.p.) is not more than that necessary for successful communication.

Cet appareil est conforme avec Industrie Canada, exempts de licence standard RSS(s). Son fonctionnement est soumis aux deux conditions suivantes: 1) ce dispositif ne doit pas causer d'interférences, et 2) ce dispositif doit accepter toute interférence, y compris les interférences qui peuvent causer un mauvais fonctionnement de l'appareil.

En vertu des règlements d'Industrie Canada, cet émetteur de radio ne peut fonctionner en utilisant une antenne d'un type et maximale (ou moins) Gain approuvé pour l'émetteur par Industrie Canada. Pour réduire les interférences radio potentielles aux autres utilisateurs, le type d'antenne et son gain doivent être choisis afin que la puissance isotrope rayonnée équivalente (PIRE) ne est pas plus de ce qui est nécessaire pour une communication réussie.

We, Venstar, declare under our sole responsibility that the device to which this declaration relates: Complies with Part 15 of the FCC Rules. Operation is subject to the following two conditions: (1) this device may not cause harmful interference, and (2) this device must accept any interference received, including interference that may cause undesired operation.

This Explorer Mini thermostat has the ability to receive updates to its firmware. Periodically firmware updates are released by the manufacturer to add features and/or performance enhancements. This manual was produced reflecting the most current firmware/feature set at the time of publication, firmware rev. 1.0. Firmware releases after rev. 1.0 may not be adequately depicted in this manual. Please refer to the appropriate website or contact your place of purchase to learn about changes to the thermostat after firmware release 1.0.



**Industry
Canada**

**Industrie
Canada**

Table of Contents

Installation Instructions	1
Wire Connections	2
Thermostat Backplate	3
Dip Switch Settings	4
Connect to WiFi	10
Front Panel	13
Display	14
Basic Operation	16
User Setup	17
Backlight Operation	18
Service Filter	19
Installer Setup	21
Programming a Daily Schedule	27
About Advanced Features & Operation	29
Advanced Setup Table	34



IMPORTANT

Follow Installation Instructions carefully. Disconnect Power to the Heater/Air Conditioner before removing the old thermostat and installing the new thermostat.

Glossary of Terms

Auto-Changeover: A mode in which the thermostat will turn on the heating or cooling based on room temperature demand.

Cool Setpoint: The warmest temperature that the space should rise to before cooling is turned on (without regard to deadband).

Deadband: The number of degrees the thermostat will wait, once a setpoint has been reached, before energizing heating or cooling.

Differential: The forced temperature difference between the heat setpoint and the cool setpoint.

Heat Setpoint: The coolest temperature that the space should drop to before heating is turned on (without regard to deadband).

Icon: The word or symbol that appears on the thermostat display.

Mode: The current operating condition of the thermostat (i.e. Off, Heat, Cool, Auto, Program On).

Non-Programmable Thermostat: A thermostat that does not have the capability of running Time Period Programming.

Programmable Thermostat: A thermostat that has the capability of running Time Period Programming.

Temperature Swing: Same as Deadband.

Time Period Programming: A program that allows the thermostat to automatically adjust the *heat setpoint* and/or the *cool setpoint* based on the time of the day.

Installation Instructions

Remove and Replace the old thermostat

To install the thermostat properly, please follow these step by step instructions. If you are unsure about any of these steps, call a qualified technician for assistance.

- Installation tools: Small flat blade screwdriver, Phillips screwdriver, wire cutters and wire strippers.



- Make sure your Heater/Air Conditioner is working properly before beginning installation of the thermostat.
- Carefully unpack the thermostat. Save the screws, any brackets, and instructions.
- Turn off the power to the Heating/Air Conditioning system at the main fuse panel. Most residential systems have a separate breaker or switch for disconnecting power to the furnace.
- Remove the cover of the old thermostat. If it does not come off easily, check for screws.
- Loosen the screws holding the thermostat base or subbase to the wall and lift away.
- If you have a smart phone handy, take a photo of the wiring for future reference.
- Disconnect the wires from the old thermostat. Tape the ends of the wires as you disconnect them, and mark them with the letter of the terminal for easy reconnection to the new thermostat.
- Keep the old thermostat for reference purposes, until your new thermostat is functioning properly.

Installation Instructions

Wire Connections

If the terminal designations on your old thermostat do not match those on the new thermostat, **refer to the chart below or the wiring diagrams that follow.**

Wire from the old thermostat terminal marked	Function	Install on the new thermostat connector marked
G or F	Fan	G
Y1, Y	Cooling	Y1
W1, W	Heating	W1/O/B
Rh, R, M, Vr, A	Power	R
C	Common	C
O/B	Rev. Valve	W1/O/B*
W2	2nd Stage Heat	W2
Ck1	Dry Contact Switch	CK
CKGND	Dry Contact Switch	R

* O/B is used if your system is a Heat Pump.

Installation Instructions

The Explorer Mini Thermostat Backplate

To remove the thermostat backplate:

Gently separate the display from the base by pulling from the center.

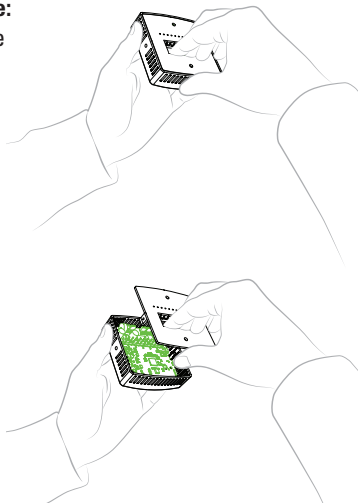
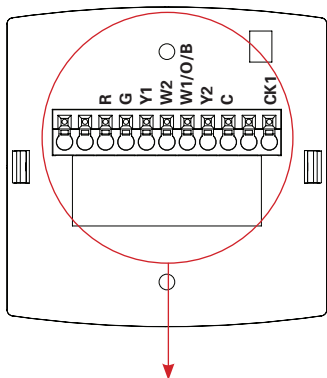

R	24 VAC return
G	Fan relay
W1/O/B	1st stage heat circuit
W2	2nd stage heat circuit
Y1	1st stage compressor relay

Y2	2nd stage compressor relay
C	24 VAC common
CK1	Dry Contact

IMPORTANT: This thermostat requires both R (24 VAC Return) and C (24 VAC Common) wires be connected to the backplate terminals to operate properly.

Installation Instructions

Check Dip Switch

Ensure which switch is correct for your system. Dip switches are located on the back of the thermostat.

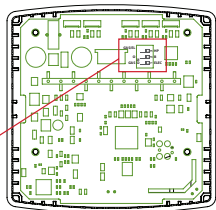

This switch (GAS or ELEC) controls how the thermostat will control the Fan (G) terminal in heating mode. When **GAS** is chosen, the thermostat will not energize the Fan (G) terminal in heating. When **ELEC** is chosen the thermostat will energize the fan in heating.

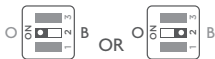

For Heat Pump Only

When the **GAS/EL** or **HP** dip switch is configured for **HP**, this dip switch (O or B) must be set to control the appropriate reversing valve. If **O** is chosen, the **W1/O/B** terminal will energize in cooling. If **B** is chosen, the **W1/O/B** terminal will energize in heating.



This dip switch configures the thermostat to control a conventional gas/electric system or a heat pump. If your system is anything other than a heat pump, leave this switch set for **GAS/EL**.

Installation Instructions

1 Stage Heat, 1 stage Cool

Dip Switch Settings

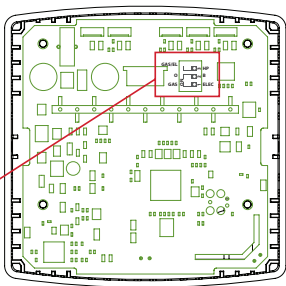
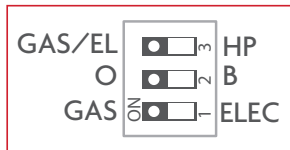

Thermostat

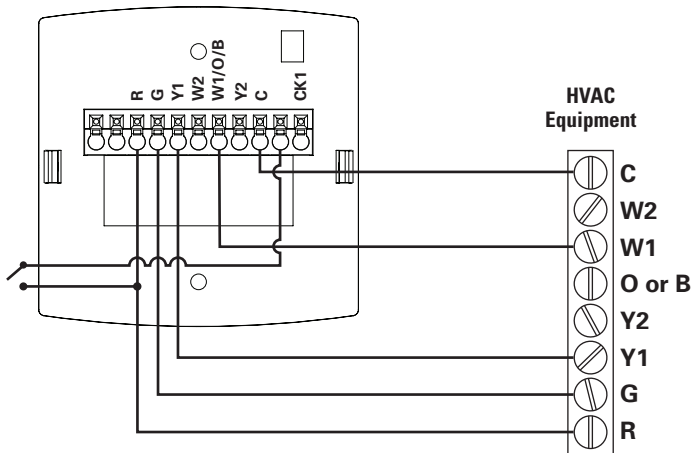

Installation Instructions

2 Stage Heat, 2 Stage Cool

Dip Switch Settings

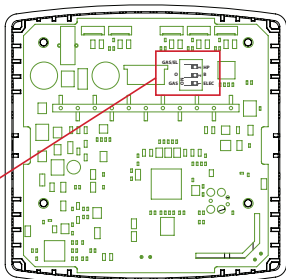
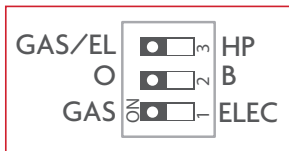

Thermostat

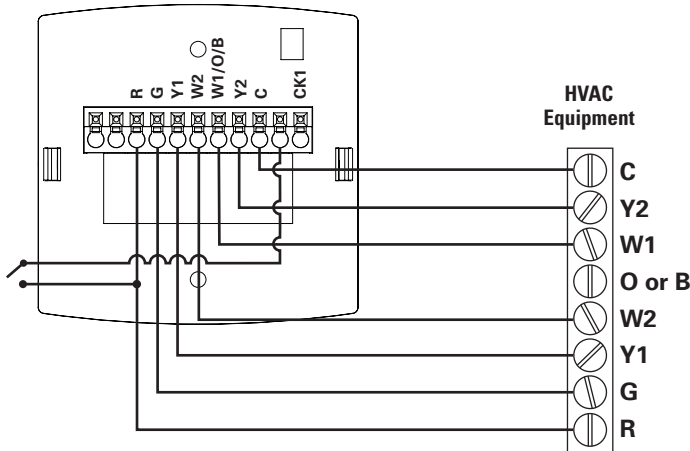

Installation Instructions

Single Stage Heat Pump with AUX Heat

Dip Switch Settings

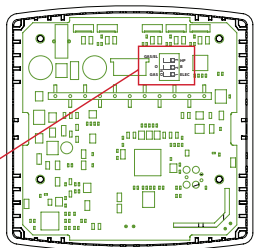
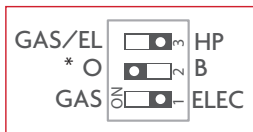

*Reversing valve choice, O or B, is dependant on the type of valve installed in the heat pump.

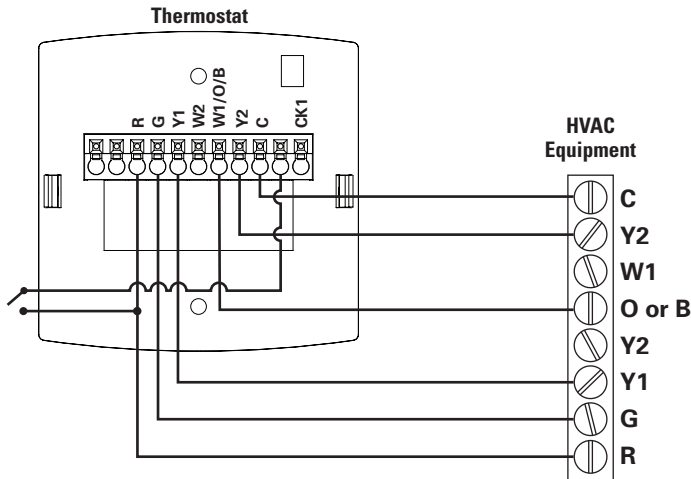

Installation Instructions

Dual Stage Heat Pump with AUX Heat

Dip Switch Settings

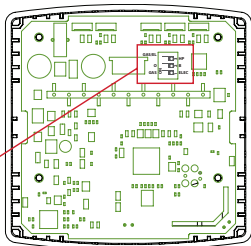
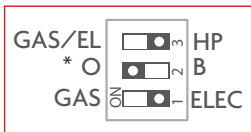

*Reversing valve choice, O or B, is dependant on the type of valve installed in the heat pump.

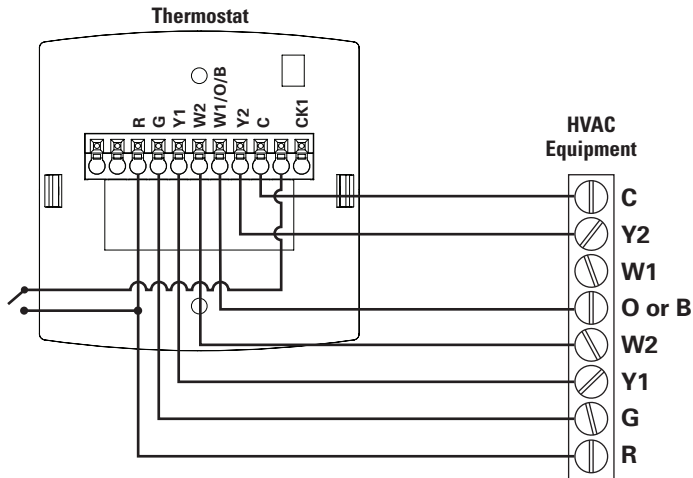

Installation Instructions

Heat Only - with Venstar 2-Wire Kit - ACC0436

Dip Switch Settings

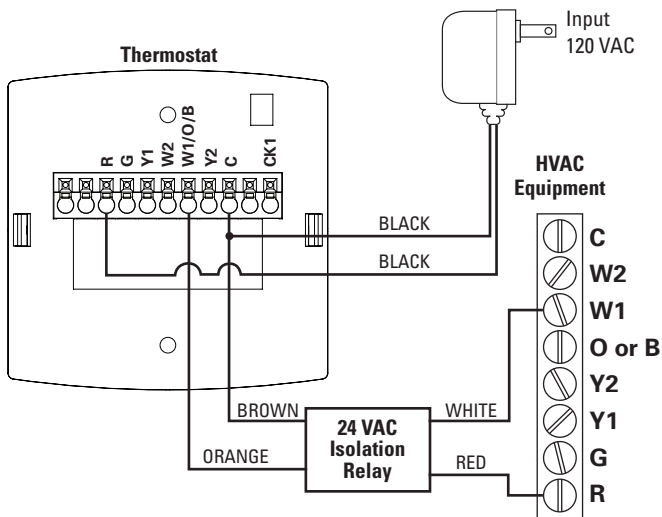
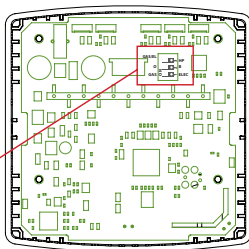
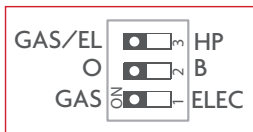

Connect to Wi-Fi Overview

At minimum the first 3 tasks below must be completed to access your thermostat remotely from a browser. The 4th step is optional (highly recommended) and only is needed to access your thermostat(s) from a mobile device.

These steps are:

1. Successful connection to a local Wi-Fi Access Point with internet access.
2. Confirm receipt of a Skyport generated verification email (this only occurs once during the Skyport account setup).
3. A 6-digit code obtained from the thermostat is successfully entered into a Skyport account.
4. Successfully download and install the Venstar Skyport app on your mobile device(s).

Your thermostat operates on the 2.4 Ghz, Wi-Fi b/g/n band.

Wi-Fi Symbol Legend



When the only the 'dot' of the Wi-Fi symbol appears = not connected to an access point.



When the full Wi-Fi symbol appears = connected to an access point.



When the full Wi-Fi symbol appears and the 'dot' of the symbol is flashing = connected to Skyport.

Connect to Wi-Fi Overview

Wi-Fi Setup

The Venstar Configurator App is needed to configure the Wi-Fi Settings of this thermostat

- **Download the Venstar Configurator App** from your mobile device's App Store.



ICON

- **Open the Venstar Configurator App**
 - Choose the Explorer Mini thermostat by sliding the thermostat pictures at the top of the apps' display to the left until you see a picture of the Explorer Mini.
 - Press and hold the FAN button of the thermostat for approximately 5 seconds to enter Wi-Fi setup screens.
 - Press the cooler button to setup Wi-Fi.
 - Follow the instructions that appear on the Venstar Configurator App.

Connect to Skyport

Although there is more than one way to create a Skyport account, the steps below illustrate account creation from a browser. To create a Skyport account a thermostat must be joined to the account.

If the thermostat is connected to the local Wi-Fi Access Point, but you do not have a Skyport account, you may create an account and join the thermostat to the account by doing the following:

1. Open your browser to: <http://venstar.skyportcloud.com>
2. Select "Create account now"

 Create Account Now

3. Follow on screen instructions to create an account and add a thermostat to the Skyport account.

Connect to Wi-Fi Overview

Join a Thermostat to Skyport

If the thermostat is connected to the local Wi-Fi access point but not yet joined to an existing Skyport account, you may join the thermostat to the account by doing the following:

1. Log in to your Skyport account.
2. Select the “Location” you want to add a thermostat into.
3. Select the “Thermostat tab”.
4. Select “+ Add thermostat”. A screen will ‘pop-up’ asking for a six digit code.
5. Press the FAN button on the thermostat for 5 seconds.
6. Press the Warmer button on the thermostat.
7. A six digit code will appear on the thermostat’s display.
8. Enter the six digit code into your Skyport account.

Wi-Fi Status Screens

Press and hold the fan button on the thermostat for 5 seconds. When “Wi-Fi Setup” appears on the display, press the MODE button. Pressing the up or down button will sequence through the following information:

- AP Name
- AP Signal Strength
- IP Address
- Skyport Status
- API Status

Front Panel

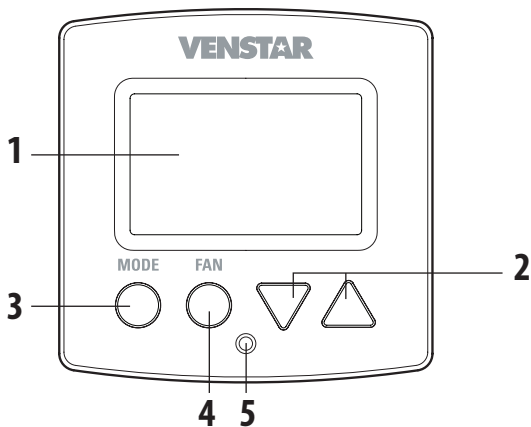

- 1 Backlit Display
- 2 Up/Warmer, Down/Cooler Buttons
- 3 Mode Button
- 4 Fan Button
- 5 Heat or Cool Indicator
Heat = Red, Cool = Green

Display

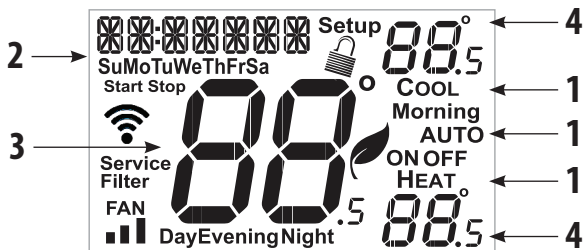

1 Mode Indicators

Selects the operational mode of the equipment.

HEAT - Indicates the heating mode.

COOL - Indicates the cooling mode.

AUTO - Indicates the system will automatically changeover between heat and cool modes as the temperature varies.

OFF - Indicates heating and cooling are turned off.

2 Clock with Day of the Week

Indicates the current time and day. This clock is also used to program the time period schedules.

3 Room Temperature Display

Indicates current room temperature.

4 Desired Set Temperature

Indicates desired room temperature(s).

Display

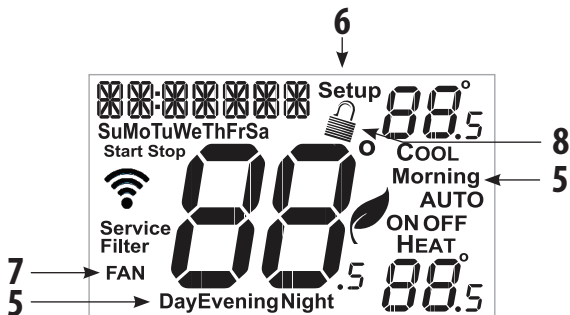

5 Morning, Day, Evening & Night icons

Indicates the day part of the time period program.

6 Setup icon

Indicates the thermostat is in the setup mode.

7 Fan icon

When only the Fan icon is displayed, the fan is always on. If the FAN is not on the display, then the FAN is in Auto mode and will run only when necessary to heat or cool.

8 Locked icon

Indicates the thermostat's control buttons have been locked.

Basic Operation

Selecting Your Desired Temperature (adjusting the setpoints)

Auto-Changeover Mode

Pressing the WARMER or COOLER buttons in Auto mode will adjust both the heat and cool setpoints simultaneously. To adjust the heat and cool setpoints individually, choose HEAT mode to adjust the heat setpoint, and COOL mode to adjust the cool setpoint, then return to AUTO mode.



Adjust the desired set temperature with these buttons

Heat or Cool Mode

Pressing the UP or DOWN buttons in Heat or Cool mode will adjust only the heat or cool set temperature.



Using the Fan Button

Fan indicates constant fan operation. You may turn the fan on even if the thermostat is in the **Off** mode. Pressing the FAN button toggles this feature on or off.



User Setup

Table for button presses that are required for entering various menus

TO ENTER MENUS	BUTTON PRESS
Setup Steps	MODE & FAN for 5 seconds
Time Schedule	MODE & Up for 2 seconds
Emergency Heat.....	Up & FAN for 2 seconds
Lockout Buttons.....	MODE, Up & Down for 2 seconds
Calibration.....	MODE & Down for 2 seconds
Wireless Setup	FAN for 5 Seconds

How to Change Settings in the Setup Screens

To enter the setup screens, press the MODE button, and simultaneously press FAN button for 5 seconds. Release the buttons when you see "Setup" on the display. Use the WARMER or COOLER buttons to adjust the value of your selection. Press MODE to advance to the next setup step. Press MODE and FAN together again to leave the setup screens.



Setting the Clock and Day (setup step 1 & 2)

When your thermostat is connected to Skyport Cloud Services, the time and day of the week are controlled by Skyport. There is no local adjustment, Skyport also adjusts the time for Daylight Savings Time as well.

To set the time and day when not connected to Skyport; enter the setup screens by pressing the Mode button and simultaneously pressing the Fan button for 5 seconds.

(Continued)

User Setup: Backlight Operation

(Continued)

Setup step 1 adjusts the clock. Use the Warmer/Up or Cooler/Down buttons to adjust the time.

Press the Mode button to advance to step 2.

Select the day of the week using the Warmer/Up or Cooler/Down buttons.

Leave the setup screens by again pressing the Mode button and simultaneously pressing the Fan button for 5 seconds.

Backlight (Setup Steps 3-6)

Backlight (setup step 3)

Off - Backlight turns on only with a button press and turns off after 8 seconds.

On - Backlight is on continuously.

Night Dimmer (setup step 4) - Selecting **On** allows for turning off the backlight of the display during specific times of the day, usually at night.

Night Dimmer Start Time (setup step 5) -
12:00 am to 12:00 am

Night Dimmer Stop Time (setup step 6) -
12:00 am to 12:00 am

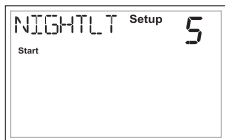
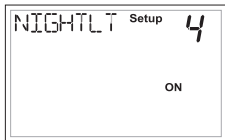
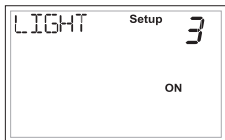

User Setup: Service Filter

These setup steps allow the user to monitor FAN runtimes and program service alerts. Service alerts appear on the display. If the thermostat is joined to a Skyport account, then the user may be alerted by Skyport Cloud Services when to change the filter.

FAN



Press and hold FAN
to clear reset runtime.

Runtime hours
or days appear in
the clock display.

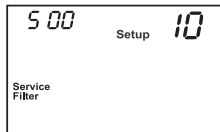

Service Filter Runtime (Setup Steps 7-10)

Current Service Filter Runtime Hours (Setup Step 7)

-This counter keeps track of the number of hours of fan runtime in the Heating mode, Cooling mode, and in stand alone Fan operation.

Press FAN to reset.



Current Service Filter Calendar Days (Setup Step 8)

-This counter displays the total number of calendar days that have elapsed since the counter was reset to help the user track Fan runtime.

Press FAN to reset.

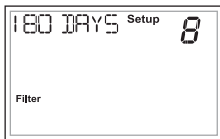

Set Service Filter Runtime Hours (Setup Step 9) -

This timer allows the user to specify the number of hours the fan will run before the "Replace Filter" alert will be displayed. Press COOLER continuously until OFF is displayed to disable this alert.



Set Service Filter Calendar Days (Setup Step 10) -

This timer allows the user to specify the number of calendar days that will elapse before the "Replace Filter" alert will be displayed. Press COOLER continuously until OFF is displayed to disable this feature.



User Setup: Setpoint Limits

Setpoint Limits (Setup Steps 11-13)

When this feature is set to ON, the Heat and Cool Setpoints may be restricted to preset levels in Setup Steps 12 and 13.



Maximum Heat Setpoint

(Setup Step 12)

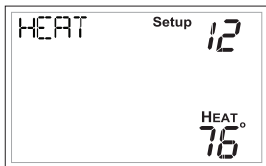

Minimum Cool Setpoint

(Setup Step 13)

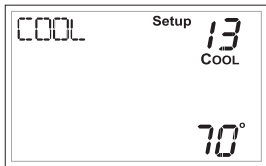

Installer Setup

Cycles Per Hour (Setup Step 14)

The Cycles Per Hour setting may limit the number of times per hour your HVAC unit may energize. For example, at a setting of 6 cycles per hour the HVAC unit will only be allowed to energize once every 10 minutes. The Cycles Per Hour limit may be overridden and reset by pressing the WARMER or COOLER buttons on the thermostat. Settings are No Limit, 2, 3, 4, 5, or 6 cycles per hour.

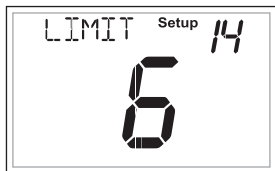

Compressor Minimum

Off Minutes (Setup Step 15)

This feature allows the user to set a minimum off time for the compressor. Settings are 0 to 5 mins.

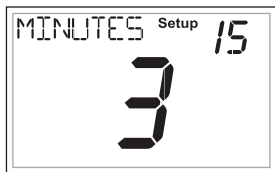

Minimum Heat/Cool Setpoint Difference (Setup Step 16)

This feature allows the user to set the minimum gap between Heat and Cool setpoints in AUTO mode. Select from 0 to 6 degrees.



Installer Setup

Deadband Settings (setup steps 17 - 20)

The Deadband is the number of degrees or minutes that the thermostat waits before it initiates the stages of heating or cooling.

1st Stage Deadband (Setup Step 17)

Specifies the temperature difference between the room temperature and the desired setpoint before the first stage of heating or cooling is allowed to turn on. (1 - 6 degrees) For example, if the heat setpoint is 68° and the 1st Stage deadband is set to 2 degrees, the room temperature will need to reach 66° before the heat turns on.

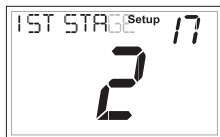

2nd Stage Deadband (Setup Step 18)

Specifies the additional temperature difference after the first stage turns on before the second stage is activated. (0° - 10°)



Minutes Between 1st and 2nd Stage

(Setup Step 19)

Specifies the minimum time (in minutes) after the first stage turns on before the second stage can turn on. (0° - 60°)

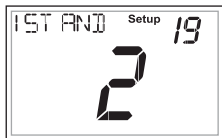

Second Stage Turnoff Point (Setup Step 20)

Specifies whether second stage will turn off at first stage deadband or remain on until the room temperature demand is satisfied. Choose between Deadband or Setpoint.

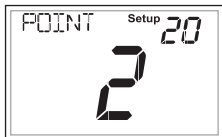

Installer Setup

Fan Off Delay in Seconds (setup step 21)

This feature allows the user to increase the cooling or electric strip heating efficiency of the system. The thermostat may be programmed to continue running the fan after a call for cooling or electric strip heating has been satisfied. This delay can be set for 0, 30, 60, 90, or 120 seconds. If set to 0, the fan will not run after a call for cooling or electric strip heating has been satisfied.



Fahrenheit or Celsius (setup step 22)

This feature allows the thermostat to display temperature in Fahrenheit or Celsius.

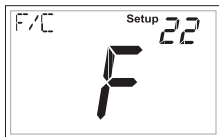

Comfort Recovery (setup step 23)

With Comfort Recovery on, the thermostat will attempt to reach the Morning setpoint temperature at the exact time programmed into the thermostat. Comfort Recovery, only works when the thermostat enters the Morning period from the Night Period. For example, if the Night Period is set for 11pm at 65°F heating and 85°F cooling, and the Morning Period is set for 6am at 72°F heating and 75°F cooling, the thermostat will turn the system on before 6am in an effort to bring the temperature to its correct setting at exactly 6am. The thermostat learns from experience, how early to turn on, so please allow 4-8 days after a program change or after initial installation to give Comfort Recovery time to adjust. If used with a heat pump, electric strip heat will be disabled while Comfort Recovery is active.

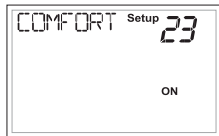

Installer Setup

Dry Contact Operation

Dry Contact Polarity (setup step 24)

Open (Normally Open) - The dry contact is open until the connected device closes the circuit.



Closed (Normally Closed) - The dry contact is closed until the connected device opens the circuit.

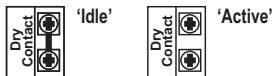

Dry Contact Use (Setup Step 25)

Condensate Pan - If selected when the Dry Contact is active, the thermostat will lockout compressor terminal(s) and "CONDENSATE PAN" will appear on the display.

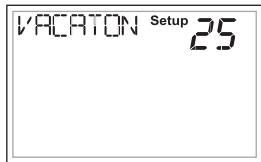

Vacation - If Vacation is selected when the dry contact is active, the thermostat will be forced into AWAY/ Unoccupied settings.

FDD - If FDD is selected when the dry contact is active, "EQUIP FAULT" will appear on the display.

Installer Setup

Skyport Cloud Services

(setup step 26)

If set to ON, the thermostat may communicate and receive data from the Skyport Cloud Services.



Local API (setup step 27)

Turning on the local API allows 3rd party software to interface with the thermostat such as a home automation system.

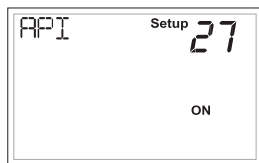

NOTE: It is permissible to enable both Skyport and the local API at the same time.

Available Modes (setup step 28)

This setup step may restrict the use of this thermostat to: Heat only or, Cool only, or Heat and Cool, or Auto changeover operation.

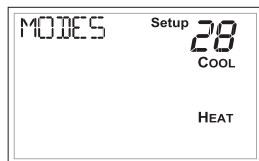

Show Clock (setup step 29)

This setup step will allow for removal of the clock and day of the week from the display. OFF removes the time and day from the display.

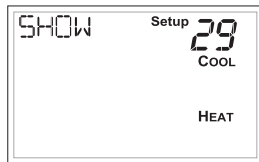

Installer Setup

Locking/Unlocking the Keypad

To prevent unauthorized use of the thermostat, the front panel buttons may be disabled. To disable, or 'lock' the keypad, press and hold the MODE button. While holding the MODE button, press the WARMER and COOLER buttons together, for two seconds.

The  icon will appear on the display, then release the buttons.

Press all three buttons in the order outlined above for keypad lockout

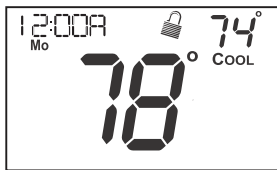

MODE



To **unlock** the keypad, press and hold the MODE button. While holding the MODE button, press the WARMER and COOLER buttons together, for two seconds.

The  icon will disappear from the display, then release the buttons.

Programming a Daily Schedule

Programming a Daily Schedule

To enter Time Period Programming screens, Press and hold **MODE** and **UP** until the scrolling prompt appears.

MODE



Select Day of Week to program -

Press the **WARMER** or **COOLER** buttons to choose the day of the week. Press **MODE** to advance to the next step.

This thermostat features four programmable time periods per 24 hour day: Morning, Day, Evening, and Night. The start time for each time period is adjustable. The stop time for each time period is the start time for the next period. Each time period, or day part may be individually disabled.

Select the Day to Program - Press the **WARMER** or **COOLER** buttons to select the desired Day of the Week.

Enable/Disable Morning Period - Press the **WARMER** or **COOLER** buttons to select **ON** or **OFF**. If the default **ON** is selected, then the Morning period will run complete with the Mode and Set Points selected. If **OFF** is selected then the Morning day part will be skipped and the thermostat will use the next day part that is enabled.

Programming a Daily Schedule

Select Morning Mode - Press the WARMER or COOLER buttons to select the desired mode, which includes OFF. Press MODE to advance to the next step.

Select Morning Start Time - Press the WARMER or COOLER buttons to adjust the time of day desired. Press MODE to advance to the next step.

Select Morning Cool Setpoint - Press the WARMER or COOLER buttons to adjust the cool setpoint desired. This step will appear if Cool or Auto Mode was selected in the step where the Morning mode is specified. Press MODE to advance to the next step.

Select Morning Heat Setpoint - Press the WARMER or COOLER buttons to adjust the heat setpoint desired. This step will appear if Heat or Auto Mode was selected in the step where the Morning mode is specified. Press MODE to advance to the next step.

Repeat Enable, Mode, Start Time and Setpoint programming for Day, Evening, and Night.

“Copy Current Day to Next Day” is available - Press the UP button to Copy the current day’s program to the next day. Press Mode again to continue copying the following day.

Press and hold the MODE/WARMER Buttons to exit Time Period Programming at any time.

About Advanced Features & Operation

Deadband Operation

Controls up to two Heat and two Cool stages.

The **1st Stage** of heat or cool is turned on when:

(A) The temperature spread from the setpoint is equal to or greater than: *the setpoint plus the 1st stage deadband*. This 1st stage deadband is adjustable from 1-6 degrees and the default is two degrees.

The **2nd Stage** of heat or cool is turned on when:

(A) The 1st Stage has been on for a minimum of two minutes (default setting).

AND

(B) The temperature spread from the setpoint is equal to or greater than: *the setpoint plus the 1st stage deadband, plus the 2nd stage deadband*. This 2nd stage deadband is adjustable from 0 - 10 degrees.

About Advanced Features & Operation

Emergency Heat

Only available if you have a Heat Pump installed. To initiate the **Emergency Heat** feature, press the **FAN** button. While holding the **FAN** button press the **UP** button for two seconds.

The display will read 'EM HEAT'
(Emergency Heat).

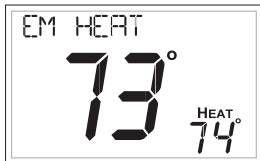

During Emergency Heat operation the thermostat will turn on the fan and the Aux strip heat when there is a demand for heat. Also during Emergency Heat, heatpump operation will be unavailable.

Exit Emergency Heat

Follow the same steps as entering **Emergency Heat** by pressing the **FAN** and **UP** buttons, for two seconds. During Emergency Heat, only OFF and HEAT modes are available by pressing the **MODE** button.

About Advanced Features & Operation

Calibration

Under normal circumstances it will not be necessary to adjust the calibration of the temperature sensor. If calibration is required, please contact a trained HVAC technician to correctly perform the following procedure.

- 1 **MODE** Place the thermostat in the OFF mode.

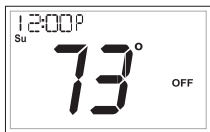

- 2 **MODE** Press and hold the MODE button. While holding the **MODE** button, press and hold the **DOWN** button for 5 seconds.



All icons will appear on the display.

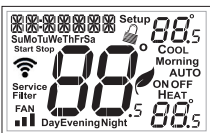

- 3 **MODE** Press the **MODE** button once. The thermostat temperature will be displayed and may be calibrated using the **UP** or **DOWN** buttons. The calibrated offset from the "raw" temperature reading is displayed in the lower right corner.



Additionally, on this screen you may view the Software Version in the upper left corner.

- 4 **MODE** After calibration is complete, press the **MODE** button **once** to save your changes and return to normal operation.

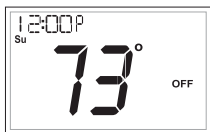



About Advanced Features & Operation

Factory Defaults

If, for any reason, you desire to return all the stored settings back to the factory default settings, follow the instructions below.

WARNING: This will reset all Time Period and Advanced Programming to the default settings. Any information entered prior to this reset will be permanently lost.

- 1 **MODE**
 Place the thermostat in the OFF mode.

- 2 **MODE**

 Press and hold the MODE button. While holding the MODE button, press and hold the DOWN button for 5 seconds. All icons will appear on the display.

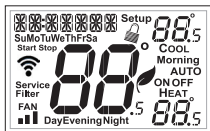
- 3 **FAN**
 **A.** After all of the icons appear, release the MODE and DOWN buttons.
B. Press and hold the FAN button for 2 seconds. Fd (Factory default settings) and ALL will appear on the display.



(Continued)

About Advanced Features & Operation

(Continued)

You now have the option of restoring the factory settings to just Wi-Fi (**Wi-Fi**), or just the thermostat (**STAT**), or both the thermostat and Wi-Fi (**ALL**).

C. Select one of the above options using the Up or Down buttons.

D. Press Fan for 2 seconds to restore the factory settings.



After factory settings are restored, the thermostat display will return to the "all icon" screen.

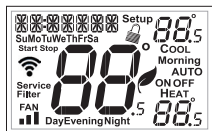

4



To return to normal operation;
Press the **MODE** button twice.

Advanced Setup Table

FD = Factory Default Setting

Step#	Description	Pg#	Range	FD
1	Set Clock	17	12A - 12A	
2	Set Day of Week	17	Monday - Sunday	
3	Backlight	18	On, Off, 6pm-6am	Off
4	Night Dimmer	18	On/Off	Off
5	Night Dimmer Start Time	18	12A - 12A	8:00PM
6	Night Dimmer Stop Time	18	12A - 12A	6:00AM
7	Current Service Filter Runtime Hours	19	0-1999 Hours	0
8	Current Service Filter Calendar Days	19	0-720 Hours	0
9	Set Service Filter Runtime Hours	19	0-1999 Hours	0
10	Set Service Filter Calendar Days	19	0-720 Days	0
11	Setpoint Limits	20	On, Off	Off
12	Maximum Heat Setpoint Limit	20	35 - 99 Degrees	74
13	Minimum Cool Setpoint Limit	20	35 - 99 Degrees	70
14	Cycles Per Hour	21	No Limit, 2, 3, 4, 5, 6	6
15	Compressor Minimum Off Minutes	21	0, 3, 5 Minutes	5
16	Min. Heat/Cool Setpoint Difference	21	0 - 6 Degrees	2
17	1st Stage Deadband	22	1 - 6 Degrees	2
18	2nd Stage Deadband	22	0 - 10 Degrees	2
19	Minutes Between 1st and 2nd Stage	22	0 - 60 Minutes	2
20	2nd Stage Turnoff Point	22	Deadband, Setpoint	Deadband
21	Fan Off Delay	23	0, 120 Seconds	0
22	F/C	23	Fahrenheit (F), Celsius (C)	F
23	Comfort Recovery	23	On, Off	Off
24	Dry Contact Polarity	24	Open, Closed	Open
25	Dry Contact Use	24	Condensate Pan, Vacation, FDD	Vacation
26	Skyport	25	On, Off	On
27	Local API	25	On, Off	Off
28	Available Modes	25	Heat, Cool, Heat or Cool, Auto	Auto
29	Show Clock	25	On, Off	On

Table for button presses that are required for entering various menus

TO ENTER MENUS

Setup Steps	MODE & FAN for 5 seconds
Time Schedule	MODE & Up for 2 seconds
Emergency Heat	Up & FAN for 2 seconds
Lockout Buttons	MODE, Up & Down for 2 seconds
Calibration	MODE & Down for 2 seconds
Wireless Setup	FAN for 5 Seconds

BUTTON PRESS

Warranty

One-Year Warranty - This Product is warranted to be free from defects in material and workmanship. If it appears within one year from the date of original installation, whether or not actual use begins on that date, that the product does not meet this warranty, a new or remanufactured part, at the manufacturer's sole option to replace any defective part, will be provided without charge for the part itself provided the defective part is returned to the distributor through a qualified servicing dealer.

THIS WARRANTY DOES NOT INCLUDE LABOR OR OTHER COSTS incurred for diagnosing, repairing, removing, installing, shipping, servicing or handling of either defective parts or replacement parts. Such costs may be covered by a separate warranty provided by the installer.

THIS WARRANTY APPLIES ONLY TO PRODUCTS IN THEIR ORIGINAL INSTALLATION LOCATION AND BECOMES VOID UPON REINSTALLATION.

LIMITATIONS OF WARRANTIES – ALL IMPLIED WARRANTIES (INCLUDING IMPLIED WARRANTIES OF FITNESS FOR A PARTICULAR PURPOSE AND MERCHANTABILITY) ARE HEREBY LIMITED IN DURATION TO THE PERIOD FOR WHICH THE LIMITED WARRANTY IS GIVEN. SOME STATES DO NOT ALLOW LIMITATIONS ON HOW LONG AN IMPLIED WARRANTY LASTS, SO THE ABOVE MAY NOT APPLY TO YOU. THE EXPRESSED WARRANTIES MADE IN THIS WARRANTY ARE EXCLUSIVE AND MAY NOT BE ALTERED, ENLARGED, OR CHANGED BY ANY DISTRIBUTOR, DEALER, OR OTHER PERSON WHATSOEVER.

ALL WORK UNDER THE TERMS OF THIS WARRANTY SHALL BE PERFORMED DURING NORMAL WORKING HOURS. ALL REPLACEMENT PARTS, WHETHER NEW OR REMANUFACTURED, ASSUME AS THEIR WARRANTY PERIOD ONLY THE REMAINING TIME PERIOD OF THIS WARRANTY. THE

MANUFACTURER WILL NOT BE RESPONSIBLE FOR:

1. Normal maintenance as outlined in the installation and servicing instructions or owner's manual, including filter cleaning and/or replacement and lubrication.
2. Damage or repairs required as a consequence of faulty installation, misapplication, abuse, improper servicing, unauthorized alteration or improper operation.
3. Failure to start due to voltage conditions, blown fuses, open circuit breakers or other damages due to the inadequacy or interruption of electrical service.
4. Damage as a result of floods, winds, fires, lightning, accidents, corrosive environments or other conditions beyond the control of the Manufacturer.
5. Parts not supplied or designated by the Manufacturer, or damages resulting from their use.
6. Manufacturer products installed outside the continental U.S.A., Alaska, Hawaii, and Canada.
7. Electricity or fuel costs or increases in electricity or fuel costs for any reason whatsoever including additional or unusual use of supplemental electric heat.
8. ANY SPECIAL INDIRECT OR CONSEQUENTIAL PROPERTY OR COMMERCIAL DAMAGE OF ANY NATURE WHATSOEVER. Some states do not allow the exclusion of incidental or consequential damages, so the above may not apply to you.

This warranty gives you specific legal rights and you may also have other rights which may vary from state to state.



Printed on recycled paper.
P/N 88-1192 12/17

VENSTAR®