

# VENSTAR®

RESIDENTIAL  
THERMOSTAT

DIGITAL  
THERMOSTAT

T1050



**5+2 DAY**  
PROGRAMMABLE

UP TO 2-HEAT  
& 2-COOL

HEAT  
COOL & HEAT  
PUMP

- Control up to 2 heat & 2 Cool Stages
- 4 Settings Per Day
- Self-prompting programming
- Auto changeover
- Separate weekday, Saturday & Sunday programming
- Back-Lit display
- One For All™ Works with Virtually All Equipment
- 5 minute Built-In Compressor Protection
- Non-Volatile memory
- Dual setpoint with adjustable deadband
- Keypad lockout
- 'O' or 'B' Terminal
- Display either F° or C°

• Use with most Air Conditioning & Heating Systems including: 1 or 2 Stage Electric Cooling & 2 Stage Gas Heating, Heat Pump, Electric or Hydronic Heat.



**OWNER'S  
MANUAL**

© Venstar Inc. 08/07

## Table Of Contents

<b>FRONT PANEL</b>	2
<b>DISPLAY</b>	3
<b>QUICK START</b> <i>Set the clock and go</i>	5
<b>SELECTING THE HEAT OR COOL MODE</b>	6
<b>BASIC OPERATION</b>	7
<b>PROGRAMMING A DAILY SCHEDULE</b>	8
<b>ADVANCED SETUP</b>	11
<b>ABOUT ADVANCED FEATURES &amp; OPERATION</b>	15
<b>WARRANTY</b>	19

---

**CAUTION** Follow *Installation Instructions* carefully.  
 DISCONNECT POWER TO THE HEATER -  
AIR CONDITIONER BEFORE REMOVING  
THE OLD THERMOSTAT AND INSTALLING  
THE NEW THERMOSTAT.



**WARNING**

---

© Venstar Inc. 08/07

**P/N T1050**

## Front Panel

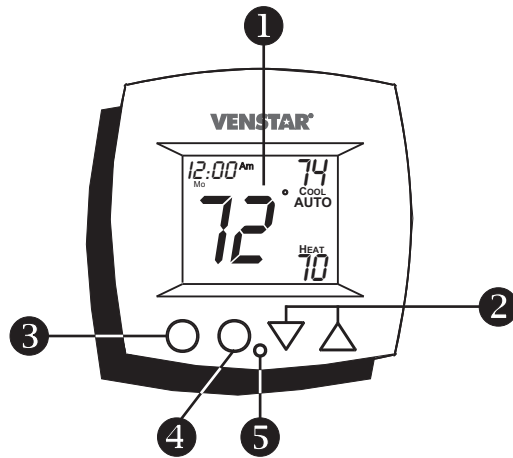

- 1** Liquid Crystal Display  
*with Thermoglow™*
- 2** Up/Down Buttons
- 3** Mode Button
- 4** Fan Button
- 5** Heat or Cool Indicator  
Red = Heat, Green = Cool

## Display

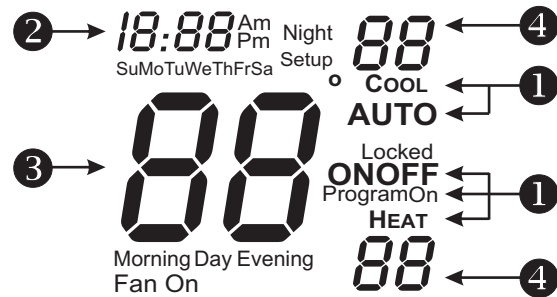

- 1** Mode Indicators - *Page 6*  
 Selects the operational mode of the equipment.  
**HEAT** - Indicates the heating mode.  
**COOL** - Indicates the air conditioning mode.  
**AUTO** - Indicates the system will automatically  
 changeover between heat and cool modes  
 as the temperature varies.  
**PROGRAM ON** - Indicates the time period  
 program is enabled to run.  
**OFF** - Indicates heating and cooling are turned off.
- 2** Clock with Day of the Week - *Page 5*  
 Indicates the current time and day. This clock is  
 also used to program the time period schedules.
- 3** Room Temperature Display  
 Indicates current room temperature.
- 4** Desired Set Temperature - *Page 7*  
 Indicates desired room temperature(s).

## Display

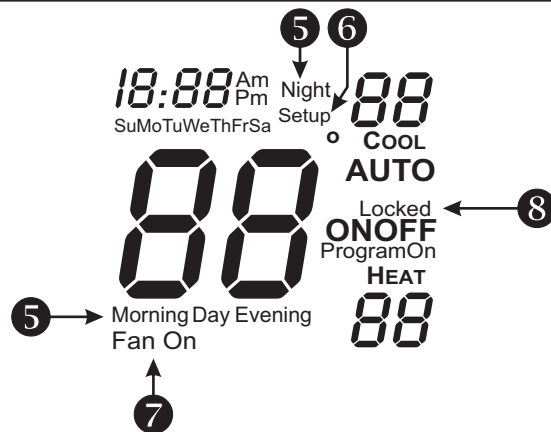

- 5** **Morning, Day, Evening & Night** icons - *Pages 8-10*  
Indicates the day part of the time period program.
- 6** **Setup** icon - *Pages 11-13*  
Indicates the thermostat is in the setup mode.
- 7** **Fan On** icon - *Page 7*  
Indicates constant, continuous fan operation.  
When **Fan On** is not lit - indicates the fan will only operate when necessary to heat or to cool.
- 8** **Locked** icon - *Page 18*  
Indicates the keypad has been locked.

## Quick Start *Set the Clock and Go*



Press the **MODE** and **FAN** buttons at the same time for two seconds to enter Setup screens.

*During Setup & Programming:*

*Pressing the UP or DOWN buttons will modify the flashing selection.*

### *Setting the Clock*

12:00<sup>Am</sup> Setup 1

*Tip: To change hours quickly, press and hold the FAN button and press the UP or DOWN buttons.*

### *Setting the Day*

Mo Setup 2

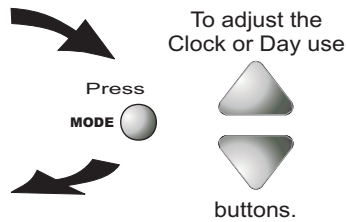

Press the **MODE** and **FAN** buttons at the same time to return to normal operation.



The thermostat is preprogrammed from the factory to operate one or two stage equipment\* without the need for further programming. To optimize the installation of this thermostat, follow the instructions in the Advanced Setup section.

*\* The thermostat is not preprogrammed from the factory to operate electric heat or heat pump systems. To control these systems, follow the steps in the Advanced Setup section, pages 11 & 12.*

## Selecting the Heat or Cool Mode

### Select Mode by Pressing the MODE Button

#### Heating Only

The **HEAT** setting indicates the temperature the room has to reach before the furnace will turn on to heat the room.

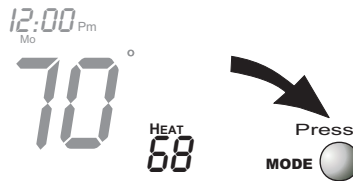

#### Cooling Only

The **COOL** setting indicates the temperature the room has to reach before the air conditioner will turn on to cool the room.

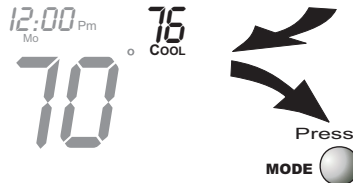

#### Heating or Cooling

**AUTO** will automatically select heat or cool based on room temperature demand.

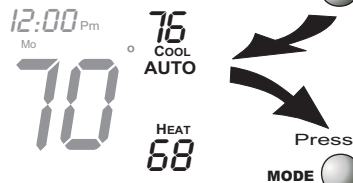

#### Time Schedule for Heating or Cooling

The **Program On** setting will activate the time period programming for the cooling or heating setpoint ONLY (Morning, Day, Evening & Night Periods).

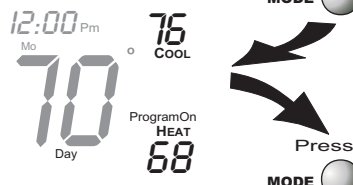

#### Off

**OFF** indicates both heating and air conditioning systems are turned off.

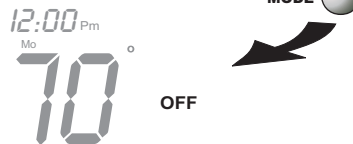

## Basic Operation

### Selecting Your Desired Temperature (adjusting the setpoints)

#### AUTO OR PROGRAM MODE

Pressing the UP or DOWN buttons in Auto or Program mode will adjust **both** the heat and cool set temperatures simultaneously.

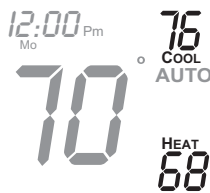

Adjust the desired set temperature with the



buttons.

#### HEAT OR COOL MODE

Pressing the UP or DOWN buttons in Heat or Cool mode will adjust only the heat or cool set temperature.



Adjust the desired set temperature with the



buttons.

### Using the Fan Button



Fan On



**Fan On** indicates constant fan operation. You may turn the fan on even if the thermostat is in the **Off** mode. Pressing the FAN button toggles this feature on or off.



## Programming a Daily Schedule

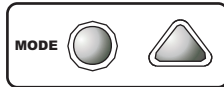

Press the **MODE** button. While holding **MODE**, press the **UP** button for two seconds to enter time period programming.

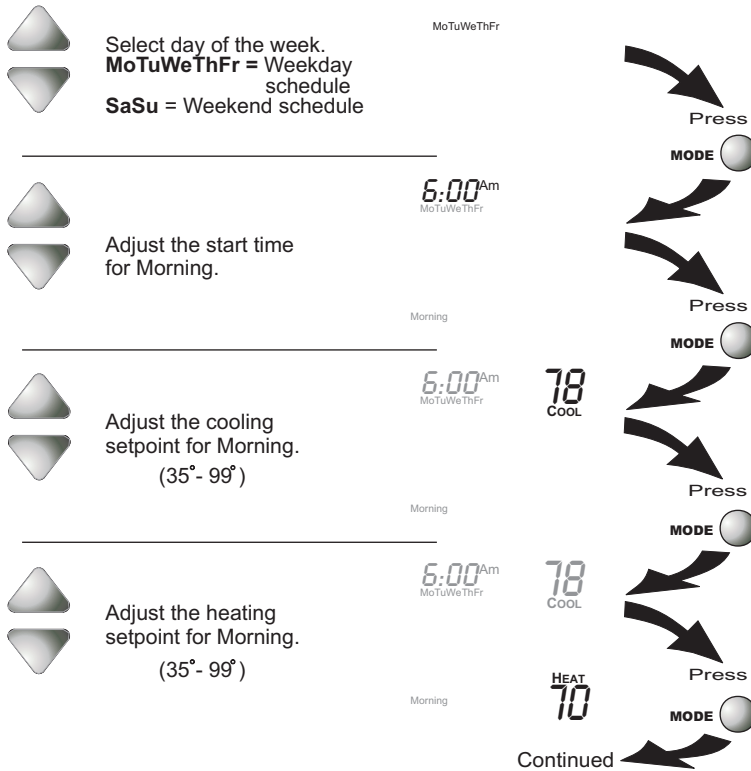

Continued

## Programming a Daily Schedule

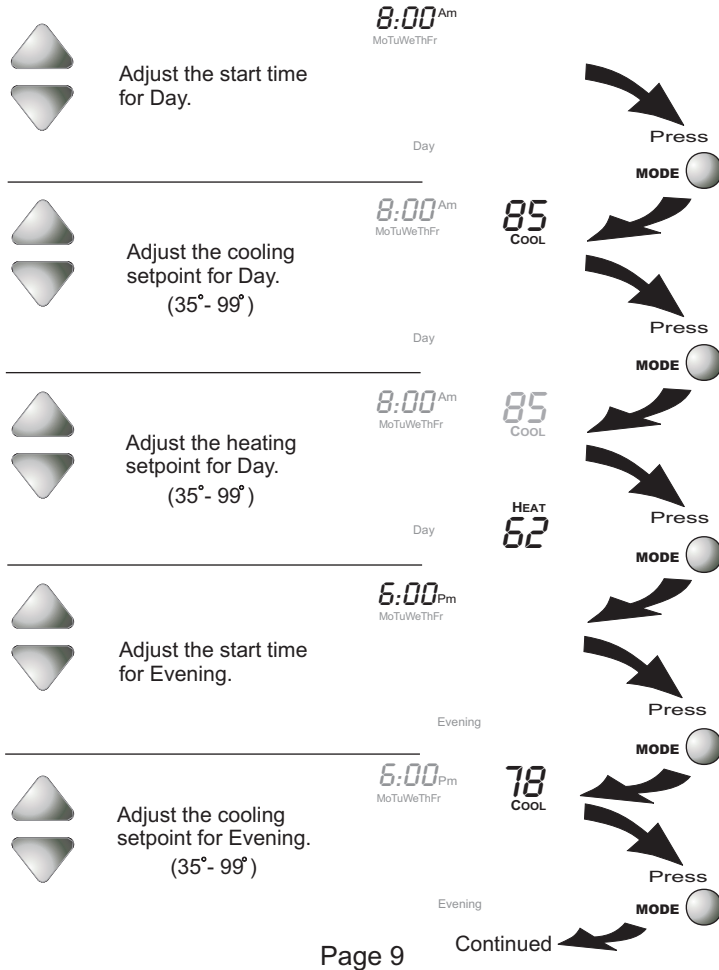

## Programming a Daily Schedule

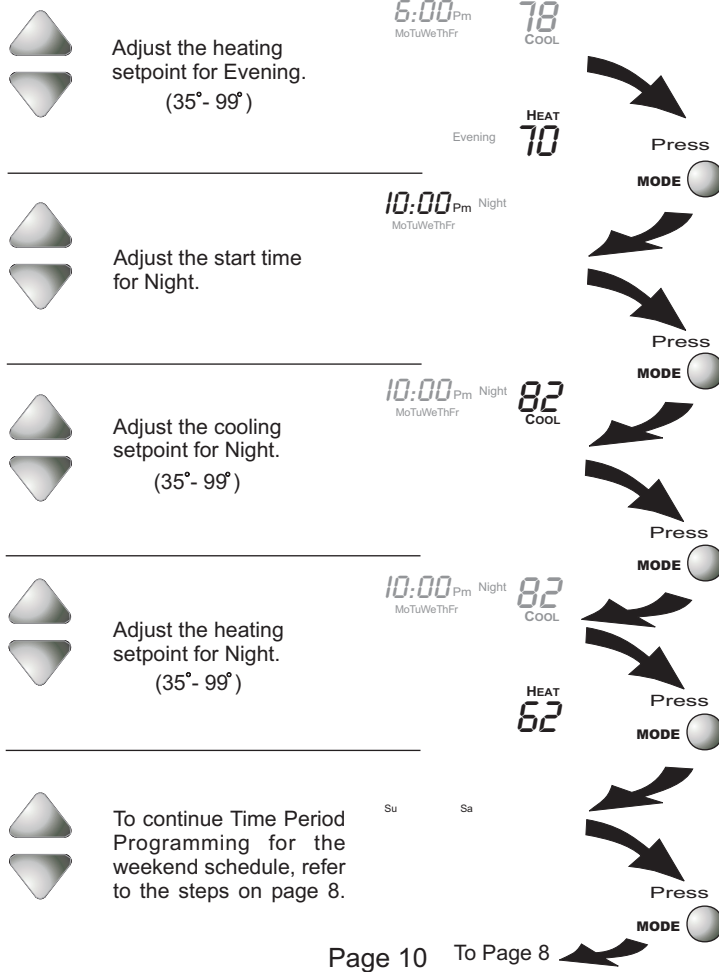

## Advanced Setup



Press the **MODE** button. While holding **MODE**, press the **FAN** button for 10 seconds to enter setup screens.

**NOTE:** Each step # is located at the top right corner of the display for easy reference.



Adjust the time of day clock.

12:00<sup>Am</sup> Setup 1

*Tip: To change hours quickly, press and hold the FAN button in and press the UP or DOWN buttons.*



Select the day of the week.

Mo Setup 2



**On** = Heat Pump operation  
**Off** = Gas Electric operation

HP Setup 3 OFF

Continued

Press

**MODE**

Press

**MODE**

Press

**MODE**

## Advanced Setup

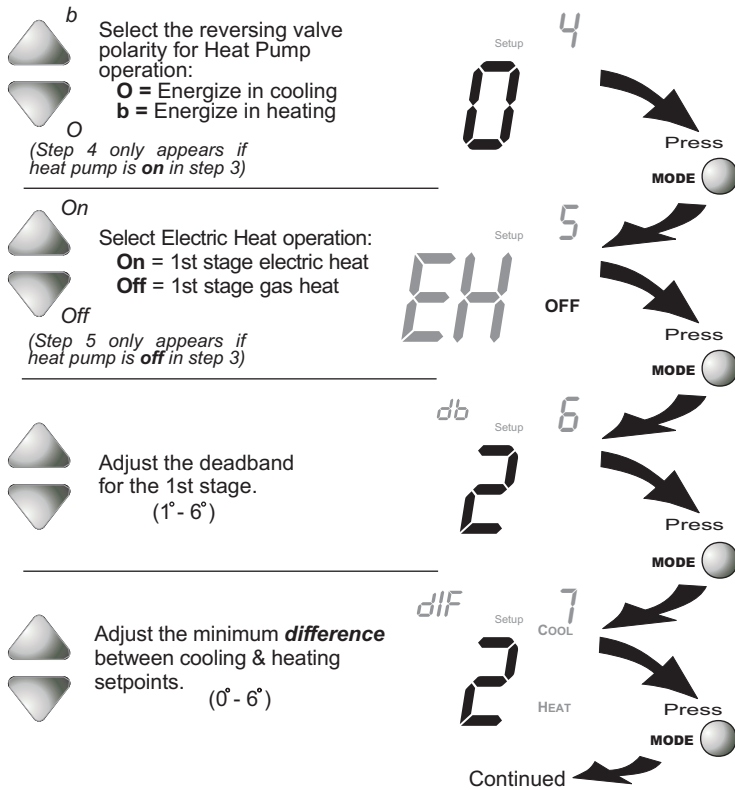

## Advanced Setup



Select the cycles per hour limit:  
 d=cycles per hour limit defeated  
 d1=d + defeat 5 min. compressor lockout  
 (d1, d, 2 - 6)

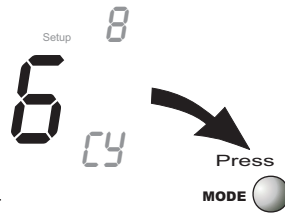

*On*  
 Select backlight operation:  
**ON** - Light continuously  
**OFF** - Light for 8 seconds after a button press  
*Off*

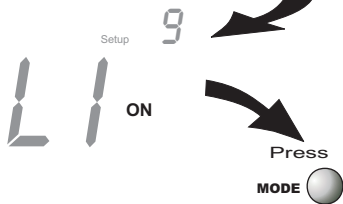

*C*  
 Select thermostat operation in degrees Fahrenheit or Celsius.  
*F*

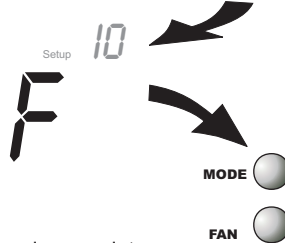

After programming is complete, press the MODE and UP buttons at the same time for two seconds to leave the Setup screens. If no buttons are pressed, the display will leave the setup screens after 30 seconds.









## Advanced Setup

### Advanced Setup Table

Step #	Description	Range	Factory Default
1	Time of Day	24 hour	12:00 am
2	Day of the Week	Mo - Su	Mo
3	Heat Pump	Off / On	Off
4	Reversing Valve Polarity	O / b	O
5	Electric Heat	Off / On	Off
6	Deadband/Temp. Swing 1st Stage	1° - 6°	2°
7	Minimum Heat/Cool Differential	0° - 6°	2°
8	Cycles Per Hour	d, d1, 2 - 6	6
9	Thermoglow Backlight	Off / On	On
10	Fahrenheit or Celsius	F / C	F

## About Advanced Features & Operation

- \* CALIBRATION - Under normal circumstances it will not be necessary to adjust the calibration of the temperature. If calibration is required, please contact a trained HVAC technician to correctly perform the following procedure.

<p><b>1</b> MODE</p> 	<p>Place the thermostat in the OFF mode.</p>		<p><b>3</b></p> 	<p>Press the MODE button once. The thermostat temperature will be displayed and may be calibrated using the UP or DOWN buttons.</p>	
<p><b>2</b> MODE</p>  	<p>Press and hold the MODE button. While holding the MODE button, press and hold the DOWN button for 5 seconds. All icons will appear on the display.</p>		<p><b>4</b> MODE</p> 	<p>After calibration is complete, press the MODE button <b>once</b> to save your changes and return to normal operation.</p>	

- \* DEADBAND OPERATION - Controls up to two Heat and two Cool stages (please see the diagram on the next page).

The **1st Stage** of heat or cool is turned on when:

- (A) The temperature spread from the setpoint is equal to or greater than: *the setpoint plus the 1st stage deadband (step #6, page 12)*. This 1st stage deadband is adjustable from 1-6 degrees and the default is two degrees.

The **2nd Stage** of heat or cool is turned on when:

- (A) The 1st Stage has been on for a minimum of *two minutes*.

**And**

- (B) The temperature spread from the setpoint is equal to or greater than: *the setpoint plus the 1st stage deadband (step #6, page 12), plus the 2nd stage deadband*. This 2nd stage deadband is fixed at two degrees and is not adjustable.



## About Advanced Features & Operation

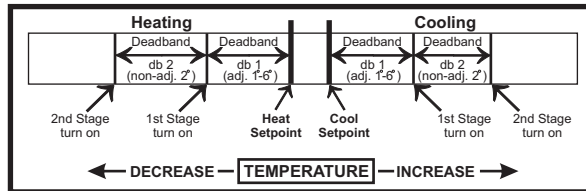

The above figure assumes the minimum on time for the prior stage has been met to allow the next stage to turn on, once the deadbands have been exceeded.

- \* **ELECTRIC HEAT** - Selecting Electric Heat (*step #5, page 12*), will cause the thermostat to turn on the fan immediately any time there is a heat demand. Since most gas furnaces control the fan, this feature should be off unless it is necessary for the thermostat to energize the fan with first stage heat.
- \* **EMERGENCY HEAT** - Only available if you have a Heat Pump installed. To initiate the Emergency Heat feature, press the FAN button. While holding the FAN button press the UP button. The Cool setpoint display will read 'EH' (emergency heat).







**Operation** - During Emergency Heat operation the thermostat will turn on the fan and the 2nd stage of heat when there is a demand for heat. Also during Emergency Heat, the 1st stage of heating or cooling will be unavailable.

**Exit Emergency Heat** - Follow the same steps as entering Emergency Heat by pressing the FAN and UP buttons. During Emergency Heat, only OFF and HEAT modes are available by pressing the MODE button.

## About Advanced Features & Operation

- \* **FACTORY DEFAULTS** - If, for any reason, you desire to return all the stored settings back to the factory default settings, follow the instructions below.

**WARNING: This will reset all Time Period and Advanced Programming to the default settings. Any information entered prior to this reset will be permanently lost.**

<p><b>1</b> MODE</p> <p>Place the thermostat in the OFF mode.</p>		<p><b>3</b> FAN</p> <p>After all of the icons appear, release the MODE and DOWN buttons. Then press and hold the FAN button for 5 seconds.</p>	
<p><b>2</b> MODE</p> <p>Press and hold the MODE button. While holding the MODE button, press and hold the DOWN button for 5 seconds. All icons will appear on the display.</p>		<p><b>4</b> MODE</p> <p>After the letters Fd appear on the display (Factory Default), release the FAN button. Press the MODE button <b>twice</b> to return to normal operation.</p>	

- \* **HEAT/COOL DIFFERENTIAL** - The Heat and Cool setpoints will not be allowed to come any closer to each other than the value set in Advanced Setup *step #7, on page 12*. This minimum difference is enforced during Auto-changeover and Program On operation.

**Note:** To increase the spread between the heating and cooling setpoints, press the MODE button until only the heat setpoint is displayed; adjust to the desired setpoint. Press the MODE button until only the cool setpoint is displayed; adjust to the desired setpoint. Press the MODE button again to enter the Auto-changeover mode where both the heat and cool setpoints are displayed.

- \* **MEMORY BACKUP** - In the event of a power loss, the thermostat will retain the stored program settings without external power or batteries.

## About Advanced Features & Operation

- \* **KEYPAD LOCKOUT** - To prevent unauthorized use of the thermostat, the front panel buttons may be disabled. To disable, or 'lock' the keypad, press and hold the MODE button. While holding the MODE button, press the UP and DOWN buttons together. The LOCKED icon will appear on the display, then release the buttons.

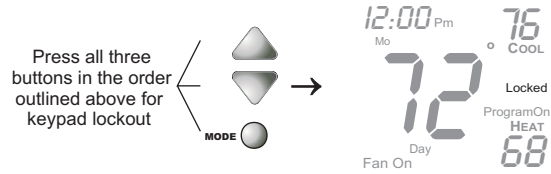

To **unlock** the keypad, press and hold the MODE button. While holding the MODE button, press the UP and DOWN buttons together. The LOCKED icon will disappear from the display, then release the buttons.

## Warranty

One-Year Warranty - This Product is warranted to be free from defects in material and workmanship. If it appears within one year from the date of original installation, whether or not actual use begins on that date, that the product does not meet this warranty, a new or remanufactured part, at the manufacturer's sole option to replace any defective part, will be provided without charge for the part itself provided the defective part is returned to the distributor through a qualified servicing dealer.

THIS WARRANTY DOES NOT INCLUDE LABOR OR OTHER COSTS incurred for diagnosing, repairing, removing, installing, shipping, servicing or handling of either defective parts or replacement parts. Such costs may be covered by a separate warranty provided by the installer.

THIS WARRANTY APPLIES ONLY TO PRODUCTS IN THEIR ORIGINAL INSTALLATION LOCATION AND BECOMES VOID UPON REINSTALLATION.

LIMITATIONS OF WARRANTIES – ALL IMPLIED WARRANTIES (INCLUDING IMPLIED WARRANTIES OF FITNESS FOR A PARTICULAR PURPOSE AND MERCHANTABILITY) ARE HEREBY LIMITED IN DURATION TO THE PERIOD FOR WHICH THE LIMITED WARRANTY IS GIVEN. SOME STATES DO NOT ALLOW LIMITATIONS ON HOW LONG AN IMPLIED WARRANTY LASTS, SO THE ABOVE MAY NOT APPLY TO YOU. THE EXPRESSED WARRANTIES MADE IN THIS WARRANTY ARE EXCLUSIVE AND MAY NOT BE ALTERED, ENLARGED, OR CHANGED BY ANY DISTRIBUTOR, DEALER, OR OTHER PERSON WHATSOEVER. ALL WORK UNDER THE TERMS OF THIS WARRANTY SHALL BE PERFORMED DURING NORMAL WORKING HOURS. ALL REPLACEMENT PARTS, WHETHER NEW OR REMANUFACTURED, ASSUME AS THEIR WARRANTY PERIOD ONLY THE REMAINING TIME PERIOD OF THIS WARRANTY.

### THE MANUFACTURER WILL NOT BE RESPONSIBLE FOR:

1. Normal maintenance as outlined in the installation and servicing instructions or owner's manual, including filter cleaning and/or replacement and lubrication.
2. Damage or repairs required as a consequence of faulty installation, misapplication, abuse, improper servicing, unauthorized alteration or improper operation.
3. Failure to start due to voltage conditions, blown fuses, open circuit breakers or other damages due to the inadequacy or interruption of electrical service.
4. Damage as a result of floods, winds, fires, lightning, accidents, corrosive environments or other conditions beyond the control of the Manufacturer.
5. Parts not supplied or designated by the Manufacturer, or damages resulting from their use.
6. Manufacturer products installed outside the continental U.S.A., Alaska, Hawaii, and Canada.
7. Electricity or fuel costs or increases in electricity or fuel costs for any reason whatsoever including additional or unusual use of supplemental electric heat.
8. ANY SPECIAL INDIRECT OR CONSEQUENTIAL PROPERTY OR COMMERCIAL DAMAGE OF ANY NATURE WHATSOEVER. Some states do not allow the exclusion of incidental or consequential damages, so the above may not apply to you.

This warranty gives you specific legal rights and you may also have other rights which may vary from state to state.